



1  
2  
3  
4  
5  
6  
7  
8  
9  
10  
11

**SG-CG/M490/I\_Smart Grid Interoperability**

Methodologies to facilitate Smart Grid system interoperability through  
standardization, system design and testing

	<b>Contents</b>	<b>Page</b>
12		
13	<b>1. Foreword</b> .....	<b>4</b>
14	<b>2. Introduction</b> .....	<b>5</b>
15	<b>3. Executive Summary</b> .....	<b>6</b>
16	<b>4. Conclusions and recommendations</b> .....	<b>7</b>
17	<b>4.1 Conclusions</b> .....	<b>7</b>
18	<b>4.2 Recommendations general</b> .....	<b>7</b>
19	<b>4.3 Recommendations for Deployment</b> .....	<b>7</b>
20	<b>4.4 Recommendations on testing</b> .....	<b>8</b>
21	<b>5. Interoperability terminology</b> .....	<b>9</b>
22	<b>5.1 Preface</b> .....	<b>9</b>
23	<b>5.2 Some definitions from the glossary</b> .....	<b>9</b>
24	<b>6. Interoperability and Standardization</b> .....	<b>10</b>
25	<b>6.1 Interoperability concepts</b> .....	<b>10</b>
26	<b>6.2 Conformance</b> .....	<b>11</b>
27	<b>6.3 Compatibility</b> .....	<b>11</b>
28	<b>6.4 Interchangeability</b> .....	<b>12</b>
29	<b>6.5 Consideration of concepts</b> .....	<b>12</b>
30	<b>6.6 Testing and validation process</b> .....	<b>12</b>
31	<b>6.7 Interoperability in the Smart Grid: The SGAM model</b> .....	<b>13</b>
32	<b>7. Methodology and Use Case identification to facilitate Interoperability</b> .....	<b>17</b>
33	<b>7.1 System Design</b> .....	<b>17</b>
34	<b>7.2 Use Case identification, creation and selection</b> .....	<b>18</b>
35	<b>8. General methodology for profile definition</b> .....	<b>20</b>
36	<b>8.1 Standards &amp; specification selection</b> .....	<b>21</b>
37	<b>8.2 Profiles</b> .....	<b>22</b>
38	<b>8.3 Basic Application Profiles (BAP)</b> .....	<b>25</b>
39	<b>8.4 Interoperability profile (IOP)</b> .....	<b>26</b>
40	<b>8.5 Basic Application Interoperability Profile (BAIOP)</b> .....	<b>26</b>
41	<b>8.6 Process from a Use Case to Interoperability on SGAM function layers</b> .....	<b>27</b>
42	<b>8.7 Managing profiles</b> .....	<b>28</b>
43	<b>8.8 Implementation of profiles in real projects</b> .....	<b>28</b>
44	<b>8.9 Experiences of creating BAPs using the process from Use Case to Interoperability</b> .....	<b>29</b>
45	<b>9. Testing</b> .....	<b>32</b>
46	<b>9.1 Testing according to the V-Model</b> .....	<b>32</b>
47	<b>9.2 Unit testing (software)</b> .....	<b>32</b>
48	<b>9.3 Unit testing/prototype testing (hardware)</b> .....	<b>32</b>
49	<b>9.4 Integration testing</b> .....	<b>32</b>
50	<b>9.5 System testing</b> .....	<b>33</b>
51	<b>9.6 Acceptance Testing</b> .....	<b>33</b>
52	<b>9.7 Testing to achieve interoperability</b> .....	<b>33</b>
53	<b>9.8 Further testing procedures</b> .....	<b>37</b>
54	<b>9.9 Experiences of creating BAIOPs for testing using the Interoperability process</b> .....	<b>37</b>
55	<b>9.10 Testing for conformance</b> .....	<b>38</b>
56	<b>10. Development of the IOP tool</b> .....	<b>40</b>
57	<b>10.1 Testing</b> .....	<b>40</b>
58	<b>10.2 Structure of the IOP Tool</b> .....	<b>40</b>
59	<b>10.3 Prioritization of Systems</b> .....	<b>44</b>
60	<b>10.4 Survey on existing IOP procedures</b> .....	<b>44</b>
61	<b>10.5 User Groups</b> .....	<b>61</b>

62	11.	Assessment related to the improvement of Interoperability in the context of Smart Grid	
63		standardization .....	65
64	11.1	Questionnaire 1 related to improvement of Interoperability in the context of Smart Grid	
65		standardization .....	65
66	11.2	Questionnaire 2 on priority where profiling is most critical / important in the context of	
67		IOP.....	66
68	12.	Annexes.....	70
69	12.1	Terms and definitions .....	70
70	12.2	Abbreviations.....	76
71	12.3	Example: Smart Grid Interoperability Specification .....	79
72	12.4	Example: Process for building an interoperable system .....	80
73	12.5	Example: BAPs and BAIOPs in EU FP7 project COTEVOS .....	82
74	12.6	Example: Standards & specification selection for DER EMS and VPP system .....	92
75	12.7	Example: Profiling of DER operation system .....	108
76	12.8	Example: use case “Control reactive power of DER unit” .....	109
77	12.9	List of figures .....	114
78	12.10	List of tables .....	116
79	12.11	Bibliography.....	117
80	12.12	References .....	118
81	12.13	Other sources .....	119
82	12.14	Summary about the work of the Working Group Interoperability .....	120

84 83

85 **1. Foreword**

86 This draft document has been prepared by the Working Group *Interoperability* (WGI) which is working under  
87 the Smart Grid Coordination Group (SG-CG) established by the European Standardization Organizations  
88 CEN, CENELEC and ETSI in order to fulfill the tasks laid down in the Mandate M/490 iteration of the  
89 European Commission.

90

91 **Tasks**

92 The main tasks for the WGI are:

93 **The first task:** “A system interoperability method” will be written in such a way that it is a methodology to  
94 facilitate the achievement of system interoperability. In this methodology, system design, use cases, testing,  
95 etc. will be introduced. The methodology will describe how these aspects will contribute towards  
96 interoperability. The methodology has a focus on Smart Grids (incl. smart metering and smart charging) and  
97 is generic in that it can be applicable for all kind of Smart Grid standards.

98 Interoperability can be achieved on different levels of the SGAM. The methodology will describe how to  
99 facilitate interoperability on these levels. It is important to note that interoperability can also mean  
100 interoperability on one SGAM communication layer only. It is up to users to adopt the methodology to  
101 achieve the desired level of interoperability applicable for them.

102 **The second task:** “Conformance testing map” will be a more detailed exploration of the item ‘Conformance  
103 testing’ and ‘interoperability testing’ in the Interoperability methodology. In this task WGI looks at the  
104 standards as defined in the parallel work on SG set of standards. WGI will develop a framework for all  
105 standards identified by SG-SS, extended by other standards, as a foundation for the profiling and testing  
106 process. It will also be helpful for identifying conformance testing and standard gaps.

107 **The third task:** “Assessment of needed profiles” will be a more detailed exploration of the item ‘Profiles’.  
108 Chapter 9 describes in detail the methodology for profile definition. Based on this WGI will provide an  
109 inventory of profiles that are already available. Besides this also an assessment of priorities based on a  
110 questionnaire circulated to all members of SGCG will be carried out.

111

112 **Focus of work**

113 In response to these tasks, this document provides a methodology to reach the requisite level of  
114 interoperability for particular Smart Grid projects. It does so by focusing on three different aspects:

- 115
- 116 • use case creation and system design.
  - 117 • creating interoperability profiles based on use cases, standards and specifications.
  - 118 • compliance, conformance and interoperability testing.

119 How and where the methodology described in this document is applied depends on the business needs. This  
120 report describes the methodology how to improve interoperability.

121 This report is meant for all stakeholders who are involved in the chain of Smart Grids. This includes policy  
122 makers, system designers, system operators, system producers and standardization organizations.

## 123 2. Introduction

124 Energy transformation is recognized as important for economic growth. By making the energy networks more  
125 intelligent through a robust, reliable and secure Smart Grid infrastructure, large savings may be provided to  
126 utilities and consumers around the world. In addition, the power grid will be made more reliable by preventing  
127 blackouts, enabling better load balancing, improving voltage and frequency stability.

128 On the consumer side we see a progressive rollout of smart meters, while in the distribution grid Smart Grid  
129 equipment is installed to monitor and control the distribution grid and to measure power quality etc.

130 The development of the Smart Grid is expected to be a long-term transition. Since the power system itself is  
131 already in place, multiple actors or stakeholders are concerned with operation, maintenance, and business  
132 aspects of the power system. Also a great number of components and applications, needed to generate,  
133 transport and distribute electrical energy, is also in place.

134 The Smart Grid as a system cannot be engineered from the ground up. Instead, Smart Grid development  
135 should be characterized as a transformation process. This means that business models and market roles on  
136 the one hand, and technical components and architectural structures on the other hand, are to be  
137 transformed from the current "legacy" state into the "Smart Grid". Due to the scale of the system and its  
138 economic importance, failures in operation and especially architectural and functional planning of the system,  
139 potentially induce high costs. In order to enable a well-structured migration process, the requirements for the  
140 Smart Grid and the current system have to be decomposed using an appropriate model.

141 In the transmission grid, Utilities are installing Phasor Measurement units (PMU's) and related Smart Grid  
142 equipment. All these smart sensors and Intelligent Electronic Devices (IED's) have integrated ICT  
143 components included. The lifecycle of the ICT component and that of the primary electrical equipment may  
144 however differ. ICT components used in the grid currently have a lifetime of around 10 to 15 years, much  
145 less than primary electrical equipment that has an average lifetime of more than 30 years. In addition to that,  
146 a major concern is technological obsolescence due to the ever increasing speed of the new evolutions of ICT  
147 components, putting at risk economic feasibility of investments in grid elements based on ICT components.  
148 In the ICT industry we see a trend from mass production to mass customization already at the more visible  
149 'front' side: user-centric application designs, 'bring your own device', customization, personalization etc. The  
150 next big mass customization trend will be to do that also in the back-office architectures, especially by  
151 introducing open standards, interoperability and a more granular (finer) modular design of components that  
152 can more easily interact. Innovations in the areas of Cloud computing, Agent technology, Internet of Things  
153 among others will further enable this transition and will be a catalyst for true distributed, decentralized,  
154 simpler architectures. Centralized architectures will be replaced more and more by distributed/decentralized  
155 variants that are truly interoperable.

156 Cyber security is a subject in the profiling. For more details see the report of the working group SG\_CG  
157 SGIS. (SG\_CG/H).

158

### 159 3. Executive Summary

160 The Smart Grid Co-ordination Group has set up a smart grid standard development methodology. A detailed  
161 description can be found in the WG Methodology report. Missing standards for smart grid can be identified  
162 and analyzed. After that, new standards will be developed, or existing standards extended. Technology  
163 providers and manufacturers are actively contributing in standardization organizations to understand the  
164 direction technology is developing in. Manufacturers use this knowledge as input to set their internal R&D  
165 programs and, in a more or less integrated way, to develop their products based on these standards.

166 As more and more ICT components are connected to the physical electrical infrastructure, interoperability is  
167 a key requirement for a robust, reliable and secure Smart Grid infrastructure. The way to achieve Smart Grid  
168 system interoperability are through detailed system specification, through use of standards, and through  
169 testing.

170 Although the majority of Smart Grid equipment is based on (inter)national standards, this does not  
171 automatically result in an interoperable Smart Grid infrastructure. This is partly due to misunderstanding of  
172 what interoperability means, what can be expected from it and what should be done to realize it. How these  
173 aspects can be used in practice requires a methodology, which is described in this report.

174 This document first defines the various terms and discusses concepts related to **interoperability** such as  
175 conformance, compatibility and interchangeability and provides a methodology to reach the desired level of  
176 interoperability (Sections 5 and 6).

177 It goes on to consider **system design**. The IT Software/System Development Life Cycle provides a widely  
178 used methodology for system development, which ensures to deliver high quality software or system  
179 effectively and efficiently (Section 7).

180 Interoperability between systems in a smart grid must be considered and well specified in **use cases**, in  
181 order to develop interoperable Smart Grid systems by design. Use cases provide a basis for the specification  
182 of functional requirements, non-functional requirements, test cases and test profiles (Section 7.2).

183 With respect to standardization, the user (utility, grid operator, energy services provider, user group etc.) will  
184 typically need to specify in detail how a specific standard (or set of standards) will be used and which options  
185 from the standards are used in what way in order to achieve the desired use case(s). This is the stage of  
186 **profile creation** (Section 8).

187 The definition of an **application profile** can be an important step achieving interoperability as it can reduce  
188 the number of options in and complexity of the full standard. Interoperability in the Smart Grid domain is  
189 further facilitated by the use of the SGAM model for Smart Grid systems.

190 To test whether the system is interoperable within the Smart Grid, two types of testing should be performed.  
191 These are conformance tests and interoperability tests (Section 9).

192 **Conformance testing** is a standalone process, to ensure that the system conforms to the selected  
193 standards or profiles. After conformance testing, the system will be connected with other systems in the  
194 Smart Grid and **interoperability testing** will be performed to ensure that functionalities over the system  
195 boundaries are working correctly.

196 The use of the above methodology is supported by the provision of an **IOP tool** which is based on the SGAM  
197 and assists the user to identify the required standards for specification, profiling and testing in terms of  
198 interoperability. Furthermore, it supports the identification of related standardization gaps (Section 10).

199 In the course of developing the methodology, certain conclusions and recommendations have also been  
200 identified in this report. These are summarized in Section 4.

201

## 202 4. Conclusions and recommendations

### 203 4.1 Conclusions

- 204 1. Assessments have shown that the understanding of the meaning of what interoperability (IOP) and  
205 profiling are, is quite different depending on the background of the persons who were interviewed in the  
206 course of this study.
- 207 2. We need to be very precise regarding what is meant by interoperability and other related terms to avoid  
208 misunderstanding. Therefore a glossary is provided containing the most suitable definitions available for  
209 interoperability purposes.
- 210 3. Profiles govern information exchange within a specific business exchange context.
- 211 4. Conformance testing with a selected standard/profile is a prerequisite for IOP testing.

212

### 213 4.2 Recommendations general

- 214 1. To avoid misunderstanding it is recommended to use one single definition of terms related to  
215 interoperability. A reference document is available.
- 216 2. If backward compatibility within versions of a standard is not possible, the responsible TC(s) should at  
217 least consider the likely need of users for a migration strategy.
- 218 3. System design is always based on user requirements. Therefore profiling should be a responsibility of the  
219 user or user groups.
- 220 4. Education of all stakeholders is needed to achieve a common understanding how profiling, defined by  
221 following the described methodology, will improve interoperability.
- 222 5. The use of the methodology of profiling in order to achieve the needed level of IOP should be considered  
223 by TCs.
- 224 6. To achieve the needed level of IOP it may be necessary for users to have a prototype conformity  
225 assessment for the system relevant devices.
- 226 7. To achieve the needed level of IOP for system relevant groups of devices (e.g. wind farms) it is more  
227 necessary for users to have an IOP conformity assessment (e.g. for devices with large rated power >  
228 1 MVA).

229

### 230 4.3 Recommendations for Deployment

231 The WGI recommendation on the profiling process is:

#### 232 a) Functional analysis

- 233 1. Select the applicable Use Cases such that the use cases and the related sequence diagrams could be  
234 considered sufficient to define functional requirements. If no Use Case is available at this stage, it  
235 needs to be created first.
- 236 2. Define on which layers IOP is required to fulfill the functional requirements of a Use Case:
  - 237 • Business layer.
  - 238 • Functional layer.
  - 239 • Information layer.
  - 240 • Communication layer.
  - 241 • Component layer.

242

#### 243 b) Standards and specification selection

- 244 3. Define required physical interfaces and communication channels between objects.



- 245 4. Select (set of) standards for each interface within each required layer with the IOP tool and also  
246 identify any gaps in conformance/compliance testing (or possibly IOP testing) in sets of standards. If  
247 necessary, specifications may be taken into account additionally.
- 248
- 249 c) Profiling based on standards and specifications as identified above; the profile is based on  
250 business/functional requirements.
- 251 5. Build IOP profiles for each (set of) standards and specifications with possible feedback into  
252 standardization development; this includes Basic Application Profiles (BAPs) and Basic Application  
253 Interoperability Profiles (BAIOPs).
- 254 6. Apply profiles in system design and testing phases.
- 255 7. Manage profiles under responsibility of User Groups<sup>1</sup> including:
- 256 • clarification on the responsibilities and roles of the different actors which are involved to create and  
257 manage profiles.
- 258 • change management, maintenance and versioning control of updated profiles with experiences of  
259 the field, tests and other feed-back.
- 260 • communication of changes to affected stakeholders.

261

262 If no User Groups exist for specific Smart Grid areas, these should be formed to meet the related IOP  
263 requirements.

264 After the profiles have been developed by User Groups, the implementation in real projects should take  
265 place. The user involved in the project is responsible for developing and maintaining Project Application  
266 Profiles (PAP and PAIOPs) based on BAPs and BAIOPs, but specific refinement still might be necessary to  
267 meet the project requirements. The user shall be also responsible to feedback experiences, implementations  
268 and options into the User Groups (see "Managing profiles").

269 As both the creation and practical application of profiles may lead to the discovery of new standardization  
270 gaps, the responsible User Groups should feedback their lessons learned directly to the corresponding  
271 standardization committees, whether on national or international level if appropriate.

272 A created profile requires a layout, format, syntax and structure to augment the application by different users  
273 in an unambiguous manner. An international standardization endeavor should be established to ensure that  
274 all interested parties may contribute to a standardized template.

275

#### 276 4.4 Recommendations on testing

- 277 1. To verify the desired level of IOP it is needed to pass the following tests as appropriate: type test, routine  
278 test, integration test, system test, factory acceptance test, site acceptance test.
- 279 2. To make testing consistent and efficient, conformance testing based on BAP should be performed before  
280 IOP tests based on BAIOP.
- 281 3. It is highly recommended that all tests which have been processed are properly documented so third  
282 parties are able to repeat the tests and verify the results.
- 283 4. The V-model<sup>2</sup> should be used for the testing process.
- 284 5. To achieve the needed level of IOP, integration testing has to be extended by system testing.

285

286

---

<sup>1</sup> A user group may consist of a single user.

<sup>2</sup> The V-Model in section 9 Figure 13 represents a system or software development process which was first proposed in the late 1980s and is still in use today. It is also applicable to hardware development. It demonstrates the relationships between each phase of the development life cycle and its associated phase of testing.



## 287 5. Interoperability terminology

### 288 5.1 Preface

289 This section provides a common understanding of some of the key terms and definitions used in our  
290 discussions regarding the state of interoperability between smart grid devices, systems and subsystems. A  
291 fuller version is included as an annex in this report which, if required or useful, can be used by other working  
292 groups. For this reason the full glossary is also available as a separate document  
293 (SGCG\_Sec0072\_DC.pdf). The description of terms in the "Interoperability glossary" is not exhaustive and  
294 does not include crosscutting issues like communication, security and privacy terms. The glossary entirely  
295 focuses on terms used for interoperability purposes.

296 Where possible, existing definitions of terms are used from other sources i.e. standards and other glossaries.  
297 Therefore reference is made to these sources. Where existing definitions are adapted for Interoperability  
298 purposes the adaptation is indicated in the glossary. Where possible the terms used in the glossary are  
299 aligned with the agreed definitions that were available within the SGCG. A limited number of terms in the  
300 glossary are not used in this report, but use of those terms is expected in future work on Interoperability.

301 For certain terms more than one definitions or descriptions were found; the definitions preferred by WGI are  
302 described in normal text fonts and definitions that can be seen as alternative descriptions are given in *Italic*  
303 *fonts*.

304 In this section some of the definitions are mentioned as seen as the most important for Interoperability use  
305 and in describing the methodology. The whole glossary is presented in the annex 12.1.

306

### 307 5.2 Some definitions from the glossary

#### 308 Compliance

309 Accordance of the whole implementation with specified requirements or standards. However, some  
310 requirements in the specified standards may not be implemented.

#### 311 Conformance

312 Accordance of the implementation of a product, process or service with all specified requirements or  
313 standards. Additional features to those in the requirements / standards may be included.

314 All features of the standard/specification are implemented and in accordance, but some additional features  
315 are not covered by the standard/specification.

#### 316 Conformance testing

317 The act of determining to what extent a single implementation conforms to the individual requirements of its  
318 base standard. An important condition in achieving interoperability is the correct implementation of the  
319 standards. This can be verified by *conformance testing*.

320 Determines whether an implementation conforms to a profile as written in the Protocol Implementation  
321 Conformance Statement (PICS). Related testing can be interoperability testing if the profile covers the  
322 interoperability requirements additional to the conformance testing requirements of standards applied.  
323 Conformance testing is a prerequisite for interoperability testing.

#### 324 Interoperability

325 The ability of two or more networks, systems, devices, applications, or components to interwork, to exchange  
326 and use information in order to perform required functions.

#### 327 Interoperability Profile

328 An IOP profile is a document that describes how standards or specifications are deployed to support the  
329 requirements of a particular application, function, community, or context.

#### 330 Interoperability Testing

331 Interoperability testing is performed to verify that communicating entities within a system are interoperable,  
332 i.e. they are able to exchange information in a semantically and syntactically correct way. During  
333 interoperability testing, entities are tested against defined profiles.

334

335 **6. Interoperability and Standardization**

336 **6.1 Interoperability concepts**

337 *Interoperability is the ability of two or more networks, systems, applications, components, or devices from the*  
 338 *same vendor, or different vendors, to exchange and subsequently use that information in order to perform*  
 339 *required functions (according IEEE 610).*

340 If two or more systems are capable of communicating and exchanging data, they are exhibiting syntactic  
 341 interoperability. Specified data formats (e.g. XML), communication protocols (TCP/IP) and the like are  
 342 fundamental tools of syntactic interoperability. This is also true for lower-level data formats, such as ensuring  
 343 alphabetical characters are stored in a same variation of ASCII or a Unicode format (for English or  
 344 international text) in all the communicating systems. Syntactical interoperability is a necessary condition for  
 345 further interoperability.

346 This concept is illustrated in Figure 1.

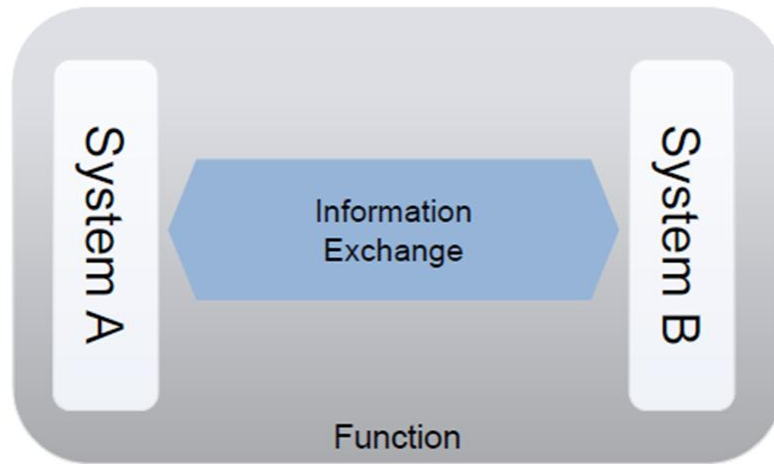

347 **Figure 1 Interoperable systems performing a function**

348 Being formulated in a general way, this concept is valid for the entire Smart Grid.

351 Note that technological developments and competition may change the nature and interoperability of  
 352 components in a Smart Grid. Thus over time it may be possible to see a greater level of interoperability, as  
 353 standardization prompts the development of products which are more closely aligned to the particular Smart  
 354 Grid implementation.

355 Equally however, it may be necessary to accept a lesser degree of interoperability within the Smart Grid if a  
 356 product, system or new standard offers benefits which outweigh any disadvantage in terms of  
 357 interoperability.

358 The following diagram in Figure 2 shows a clear picture of the key terms used in this report.

359

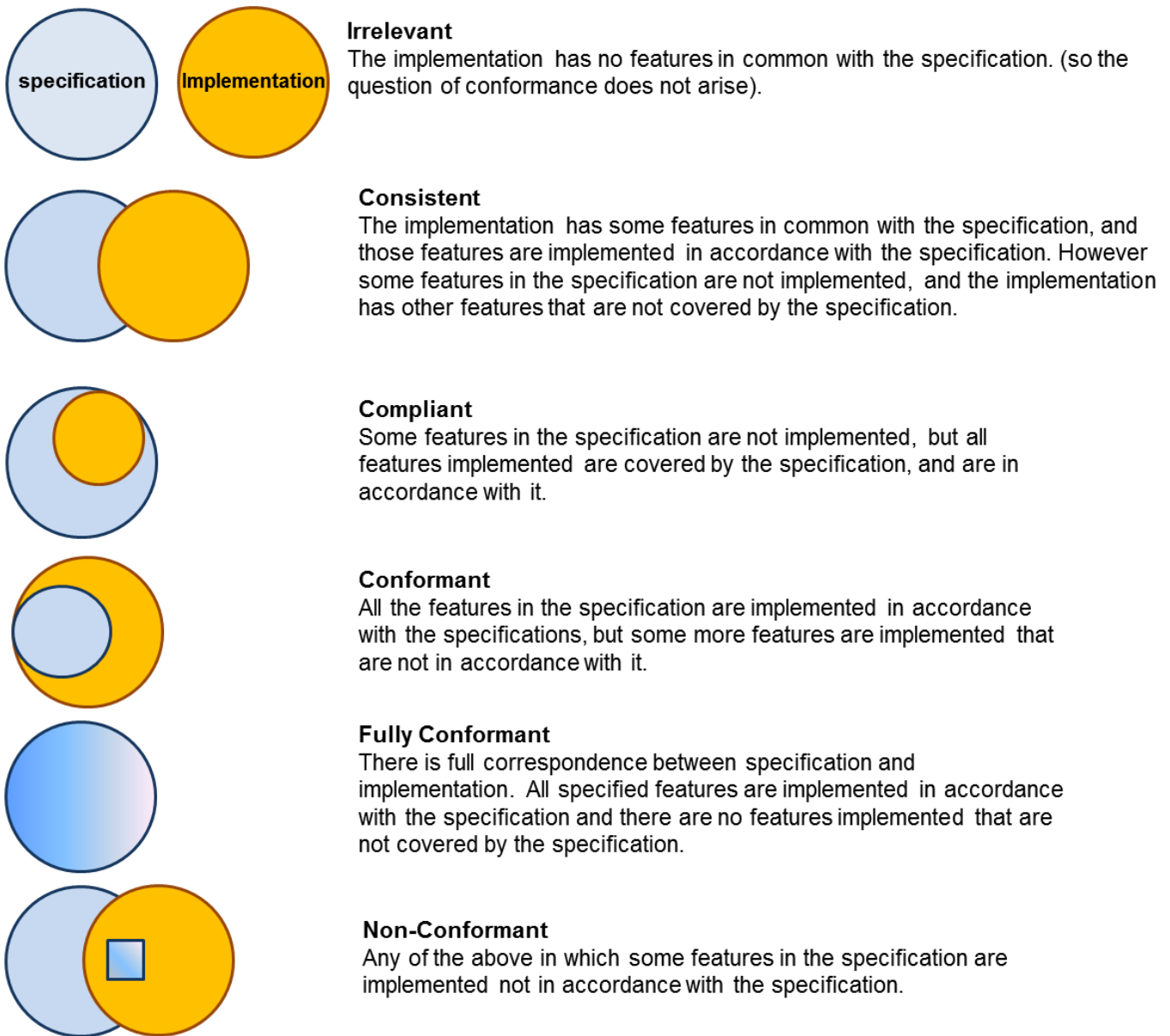

Figure 2 Conformance & Compliance

360

361

362

363 **6.2 Conformance**

364 *Conformance means that the implementation of a product, process or service with all specified requirements*  
 365 *or standards of a system (or component) is in accordance with the specified standards or authority. In the*  
 366 *interests of IOP where a standard is written it is helpful that it allows conformance to its requirements to be*  
 367 *assessed:*

- 368 • It describes the function and behavior of the product, rather than its design.
- 369 • It gives precise, measurable specifications.
- 370 • It mandates reliable and reproducible tests and methods.

371 Conformance may be assessed against a national or regional standard, or in fact against any specification.  
 372 Conformance with standards raises the possibility of Interoperability, but does not guarantee this by any  
 373 means.

374

375 **6.3 Compatibility**

376 *Compatibility is concerned with the ability of two or more systems or components to perform their required*  
 377 *functions with no modification or conversion required, while sharing the same environment (according IEEE*  
 378 *610).*

379  
380  
381  
382

Two components (or systems) can also be compatible, but perform completely separate functions. They do not need to communicate with each other, but simply be resident on the same environment – so compatibility is not concerned with interoperability.

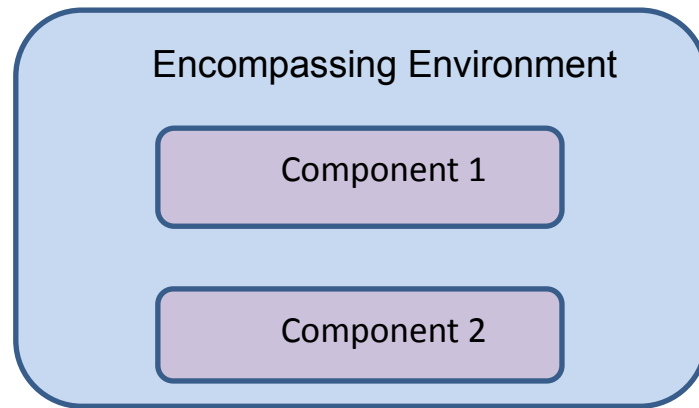

383  
384  
385

**Figure 3 Compatibility**

**6.4 Interchangeability**

*Interchangeability is the ability of two or more devices or components to be interchanged without making changes to other devices or components in the same system and without degradation in system performance. The two devices do not communicate with each other, but one can simply be replaced by another – so interchangeability is not concerned with interoperability.*

**6.5 Consideration of concepts**

As more and more ICT components are connected to the physical electrical infrastructure, interoperability is a key requirement for a robust, reliable and secure Smart Grid infrastructure. System conformance or compatibility is not enough for this goal.

Interoperability does not need to result in interchangeability for several reasons; the hardware and electrical footprint required for interchangeability may be at odds with the performance, configuration and capacity requirements for technological development. Whilst interoperability may be possible or enhanced, interchangeability may be lost.

Subject to regulatory requirements and business needs, it is generally sufficient to have interoperability, rather than interchangeability. However in certain situations, there may be a need for interchangeability.

**6.6 Testing and validation process**

Unit Tests are performed by vendors to validate the correct behavior of the software of a product. During Unit Tests the vendor validates compliance against communication-, EMC- and environmental standards as well.

Additionally compliance tests are performed by vendors in cooperation with Certification Bodies or Test Labs if the product claims compliance with a specific standard.

A Factory Acceptance Test is usually requested by a customer to validate the correct system behavior according to the specification of a contracted project together with vendor before field installation.

Multiple communication and protocol standards have standardized compliance test procedures in place. The compliance test has the purpose to demonstrate if the applicable standard(s) are correctly implemented in the Device Under Test (DUT). In case of a successful test, the manufacturer will receive an Attestation of Compliance and test report.

Customers can ask their manufacturers in the selection process for tender project test reports and Attestations of Compliance for the products the manufacturer proposes. With the help of a pilot project or prototype, the newly developed standard or the standard extension can be validated and improved through testing.

417

418

Figure 4 below shows how these processes fit within the overall timeline for standards development.

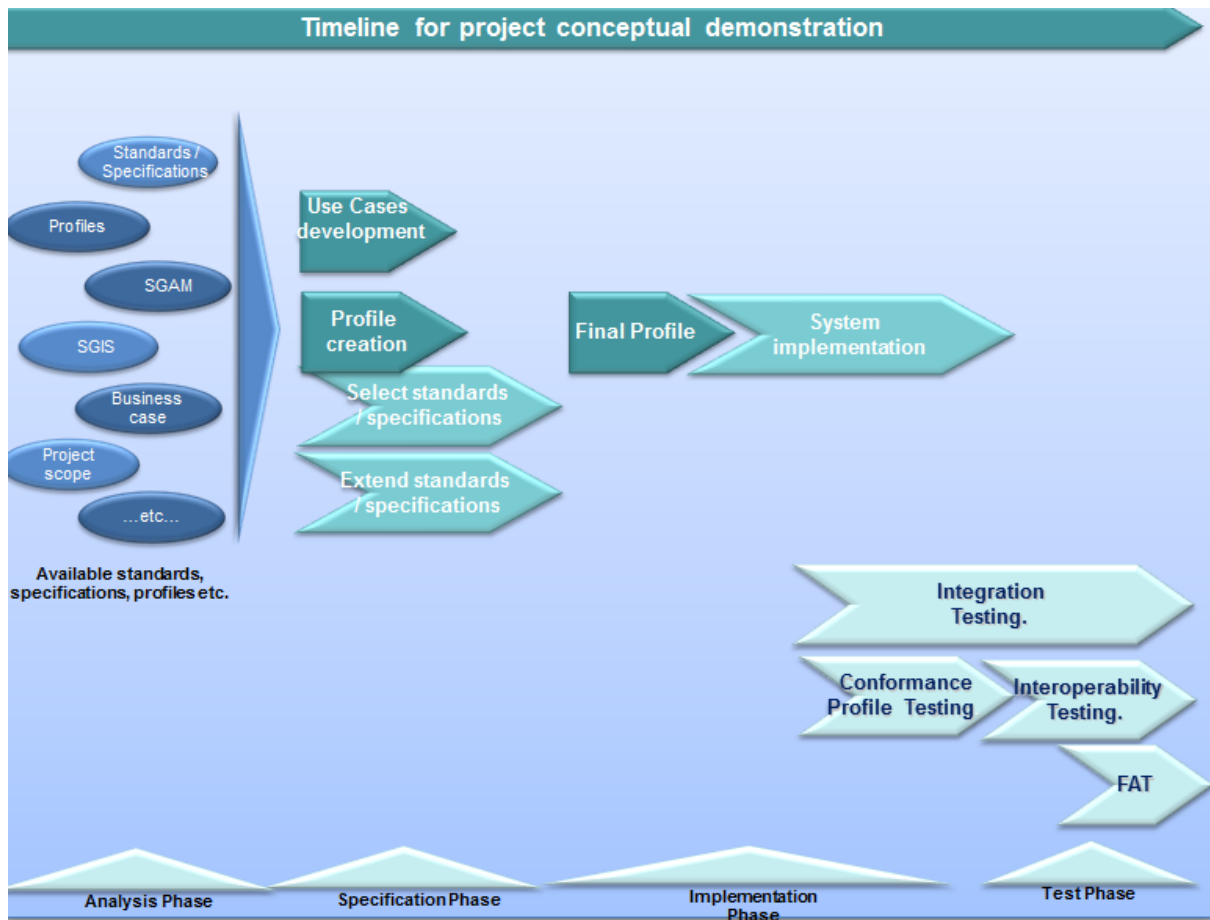

419

420

421

422

### 6.7 Interoperability in the Smart Grid: The SGAM model

423

424

425

426

427

The Smart Grid as a system exhibits a high complexity regarding organizational and technological aspects. Various actors take part in the planning and construction of the system representing several organizations and engineering domains. Therefore, a key challenge of the Smart Grid is integration, affecting components for generation, transportation, distribution, storage, and consumption of electrical energy and the supporting information systems and applications.

428

429

430

431

432

433

To create the Smart Grid as an operational system-of-systems, the functionalities and interfaces of its components must be specified beforehand. As requirements serve as the decisive factor for all further engineering activities, a suitable methodology for requirements specification and management is essential. This ensures traceability between design decisions and system requirements, supports collaboration between stakeholders by assigning responsibilities, allows the structure of the system regarding software and hardware to be derived and enables the implementation to be tested against the specification.

434

435

436

437

438

439

440

The Smart Grid as a system cannot be engineered from the ground up. Instead, Smart Grid development should be characterized as a transformation process. This means that business models and market roles on the one hand, and technical components and architectural structures on the other hand, are to be transformed from the current “legacy” state into the “Smart Grid”. Due to the scale of the system and its economic importance, failures in operation and especially architectural and functional planning of the system, potentially induce high costs. In order to enable a well-structured migration process, the requirements for the Smart Grid and the current system have to be decomposed using an appropriate model.

441

442

443

Following the definition given in this document, interoperability represents an essential requirement for the Smart Grid since it is supposed to integrate different assets and applications into one functional system. In order to support the elicitation and management of requirements, a suitable structure should be used.

444

445

From a historical point of view, the SGAM is based on the different levels of the GridWise Architecture stack. However, due to the very focus of a standardization mandate on standardization itself, dimensions like



446 business context or business processes which are not subject to standardization, had to be changed. So, the  
 447 SGAM is basically a semantically mapped and shortened version of the GWAC stack. A mapping can be  
 448 found in the M/490 Reference Architecture Working Group report<sup>3</sup>. In particular, this is important because it  
 449 leads to the fact that the GridWise Stacks Context Setting Framework can be re-used and mapped onto the  
 450 SGAM, therefore providing a meaningful Context Setting Framework for interoperability for the SGAM model.

451 The GWAC stack may serve as suitable structure for the elicitation and management of Smart Grid  
 452 requirements, since it addresses the facets of Smart Grid interoperability from regulatory policy down to the  
 453 physical connection between assets. Each layer is distinctive regarding the functions that are covered and  
 454 the abstraction level or degree of formalization of the requirements connected to them. The authors of the  
 455 model state that it may need context specific tailoring to fit the organization or generally speaking the context  
 456 it shall be applied to. An important adaptation of the GWAC model has been carried out under the European  
 457 Smart Grid mandate M/490 and forms one of the basic concepts of the Reference Architecture.

458 The model does not imply that each project should achieve interoperability on all levels. Depending on the  
 459 business needs, interoperability up to levels 3 -5 etc. can be sufficient to address current and future business  
 460 needs.

461 The GWAC stack has been basically shortened from the original SGAM model planes in the final report of  
 462 the RAWG team. Figure 5 basically shows the corresponding mapping. The GWAC stack, as mentioned  
 463 before, has been a complete eco-system also dealing with cross-cutting issues and a corresponding version  
 464 of a so called interoperability maturity model, the Smart Grid Interoperability Maturity Model (SGIMM). Figure  
 465 6 shows this particular Context Setting Framework model from the GridWise council. Figure 7 depicts how  
 466 basically the SGAM Context Setting Framework is derived from the basic GWAC model as the layer models  
 467 from GWAC and SGAM are – themselves – interoperable. With the mapping of the GWAC to SGAM planes,  
 468 a similar mapping can be done in this context to re-use the SGIMM also in the context of SGAM  
 469 interoperability assessment. Table 1 shows the corresponding Levels for the SGAM in context of the SGIMM  
 470 maturity levels. This model can be seen as an initial blue-print how to transfer the model. However, due to  
 471 the injective mapping to SGAM, additional CSF (Context Setting Framework) information has to be taken  
 472 very much into context for assessing the SGIMM with the SGAM. In addition to the GWAC stack (figure 6)  
 473 we identify the cross cutting issues like telecommunications, EMC, and Power quality.

474

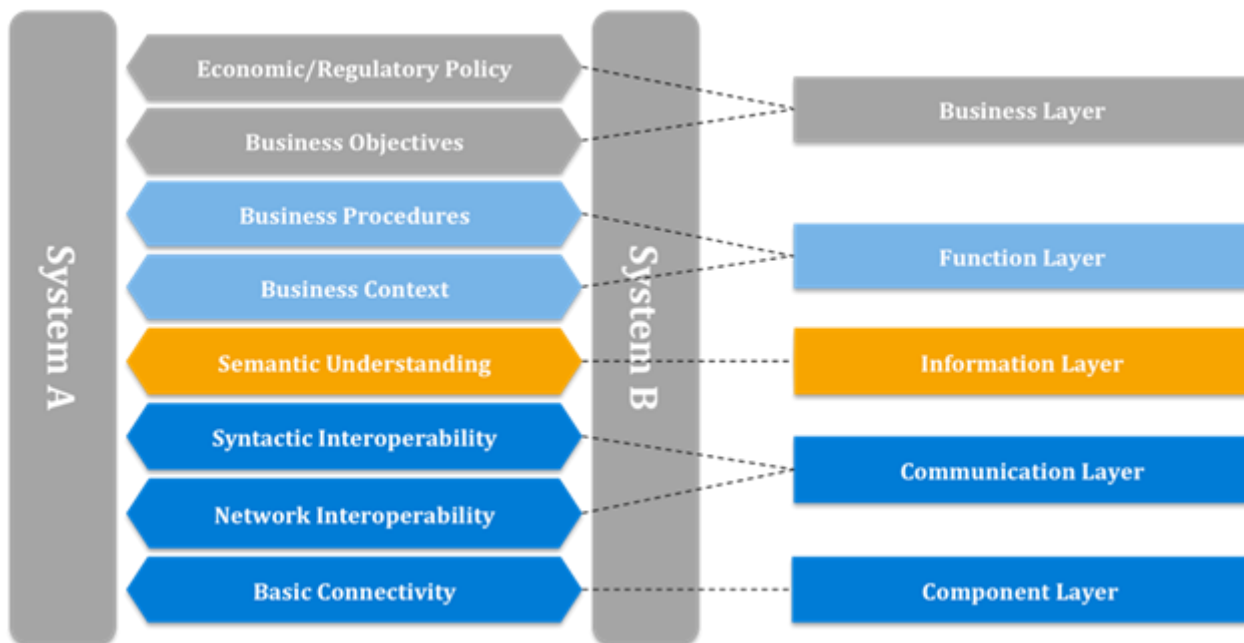

475

476

477

Figure 5 Mapping from GWAC to SGAM planes

<sup>3</sup> SG-CG/M490/C\_ Smart Grid Reference Architecture

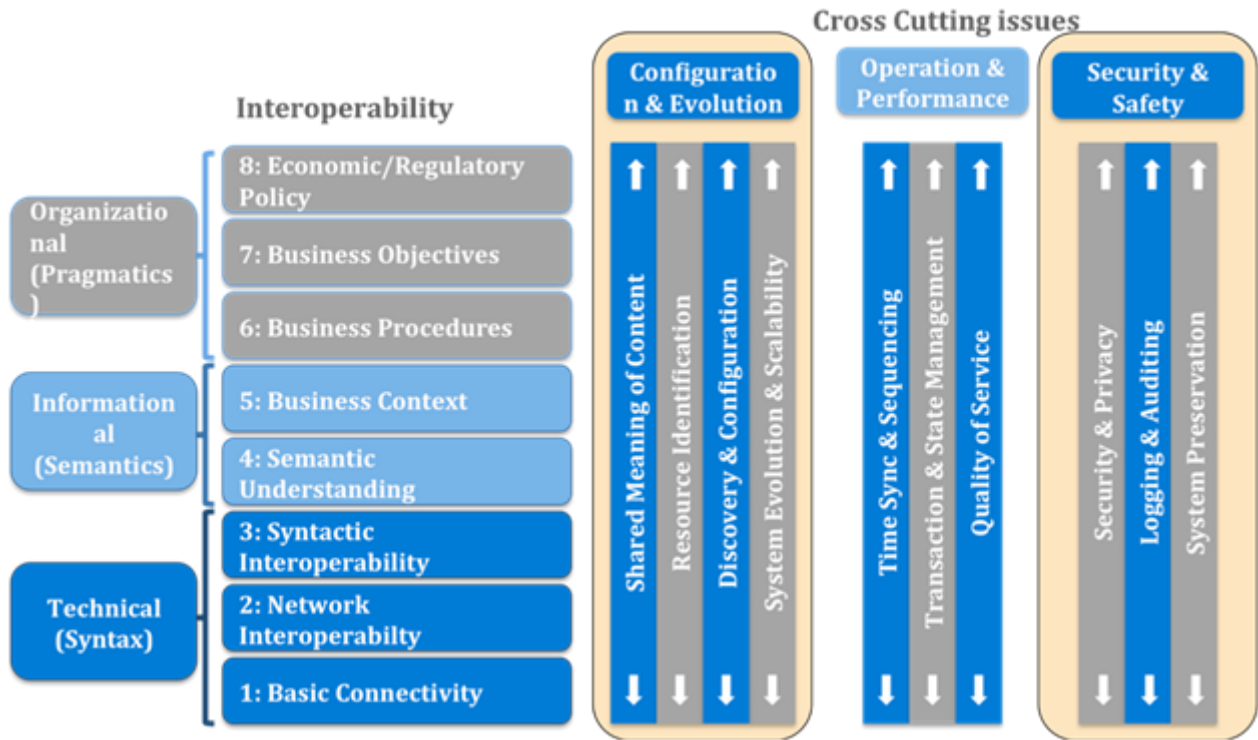

478  
479  
480  
481

Figure 6 GWAC stack Context Setting Framework

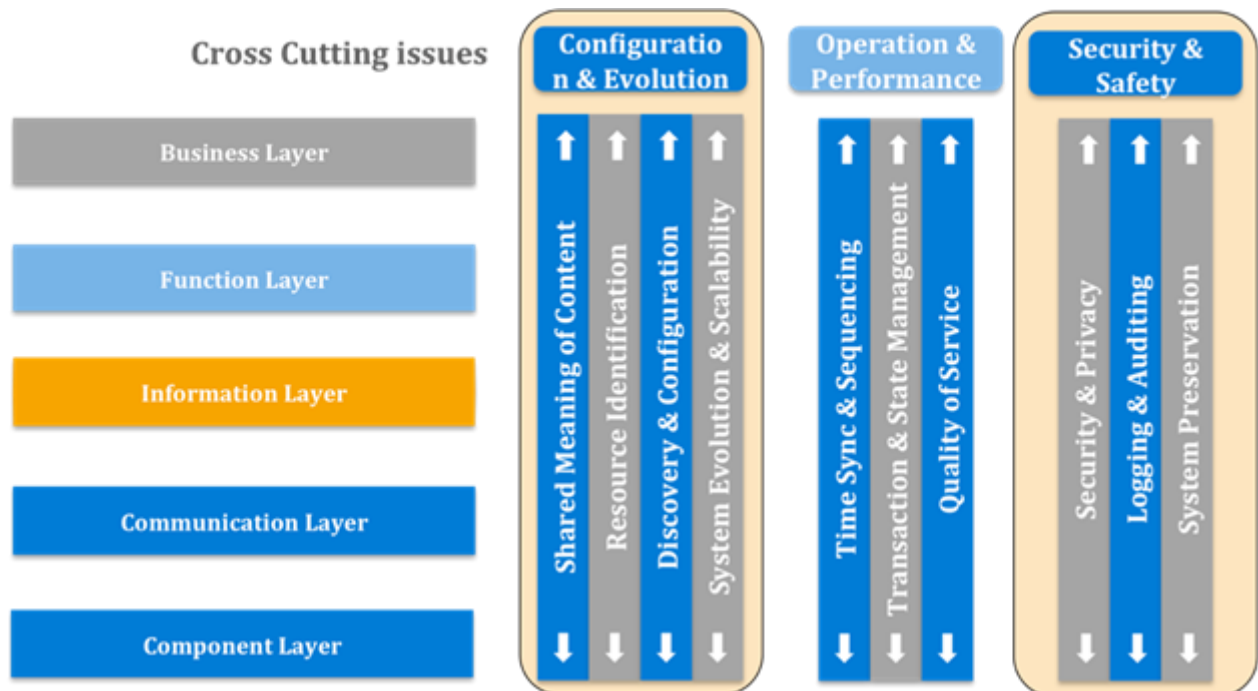

482  
483

Figure 7 Transfer from GWAC to SGAM Context Setting Framework



484

<b>Interoperability Level according to the SGIMM</b>	<b>Addressed GWAC levels</b>	<b>Addressed SGAM levels</b>
Level 5: Plug and Play	GWAC layers 1-8 and CSF requirements are implemented	SGAM layers 1-5 and all CSF requirements are implemented
Level 4: Certified, Minor but planned integration efforts	GWAC layers 1-7 and CSF requirements are MOSTLY implemented	SGAM layers 1-5 and CSF requirements without regulatory issues are implemented
Level 3: Emerging Interoperability	GWAC layers 1-5 and CSF requirements are implemented	SGAM layers 1-4 and CSF requirements without business procedures are implemented
Level 2: Initial Interoperability	GWAC layers 1-3 and CSF requirements are implemented	SGAM layers 1-2 and CSF requirements are implemented
Level 1: Non-interoperable	No awareness of 'levels'	No awareness of 'levels'

485

**Table 1 IOP level SGIMM mapping from GWAC to SGAM**

486

487 **7. Methodology and Use Case identification to facilitate Interoperability**

488 As discussed in the previous section, the use of standards facilitates interoperability-by-design when  
489 applying the correct methodology. Using standards alone will definitely not result in an interoperable system.  
490 There are other factors that need to be taken into account in seeking to reach interoperability such as:

- 491 • Designing a Smart Grid system or transforming a legacy system into an interoperable system using  
492 SGAM.
- 493 • Collecting interoperability requirements during the use case identification.
- 494 • Validation of system interoperability through testing.

495  
496 **7.1 System Design**

497 The IT Software/System Development Life Cycle is a widely used methodology for system development,  
498 which ensures the delivery of high quality software or system effectively and efficiently. This methodology  
499 can also be applied to developing smart grid energy systems. Figure 8 shows the lifecycle of system  
500 development.

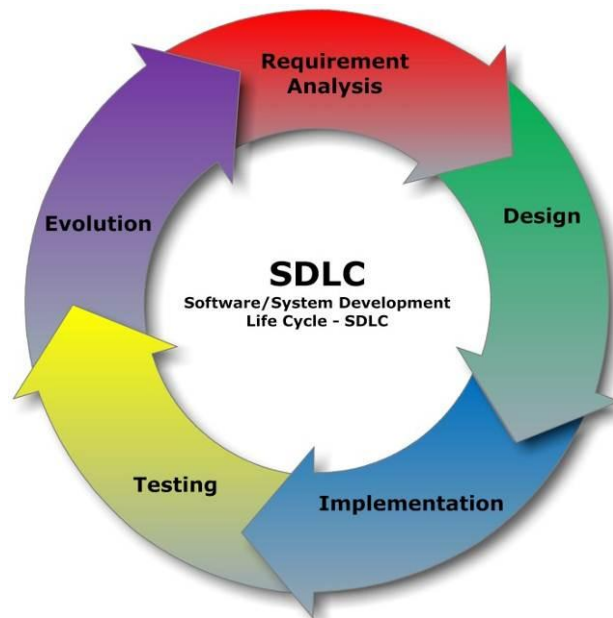

501  
502 **Figure 8 System development life cycle**

503  
504 There are five stages in the life cycle:

- 505 • Requirement analysis.
- 506 • Design.
- 507 • Implementation.
- 508 • Testing.
- 509 • Evolution.

510 Each stage has its own activities, tasks, inputs, outcomes and deliverables. Depending on which method is  
511 used for life cycle development (e.g. waterfall model, v-model, agile model etc.), the process can be slightly  
512 different. In general, at requirement analysis stage, a description of the system or software behavior will be  
513 developed, and in some cases technical feasibility will be assessed. The description of the system or  
514 software behavior can be reached through use case descriptions and functional and non-functional  
515 requirement specifications.

516 At design stage, solution concept and architecture will be considered. The realization of the solution will be  
517 developed during the implementation stage. At test stage, implemented solutions will be validated. System or  
518 software defects will be reported and corrected. After the system or software is launched in a production

519 environment, practical experiences can be gathered during maintenance and operation. New requirements  
520 to extend or improve the system or software regarding usability, performance etc. can be collected for the  
521 next life cycle iteration.

522 According to the system development life cycle methodology, requirement gatherings and specifications are  
523 processed in the first stage. In order to deliver interoperable ICT energy system management, the  
524 requirements of interoperability must be captured in this stage. Based on the requirement specifications, an  
525 interoperable energy system will be designed, implemented, tested, delivered, and successfully integrated in  
526 the Smart Grid environment.

527 The SGAM model defines the development of use cases as the starting point for functional and technical  
528 requirement definition. Based on the use case, the five interoperability layers for the system can be  
529 developed. After that, the requirements which conform to Smart Grid interoperability can be specified.

530 Since lifecycle development is an iterative process, over time period new versions of standards may be  
531 released or new versions of products will be brought into the market. Backward compatibility of the standards  
532 and new products has major influences on system interoperability. Therefore a consistent version  
533 management tool can help users to check and identify system interoperability in time. In the worst case,  
534 migration is needed to ensure further system interoperability.

535 The following sub chapters describe more details of a methodology to reach the interoperability for Smart  
536 Grid systems. From a lifecycle development point of view, backward compatibility and version management  
537 are key factors which have major influences on system interoperability.

538

## 539 7.2 Use Case identification, creation and selection

540 A use case is a description of the possible sequences of interactions between the system under discussion  
541 and its external actors, related to a particular goal<sup>4</sup>. From an interoperability point of view, systems are  
542 interoperable if two or more systems are able to perform cooperatively a specific function by using  
543 information which is exchanged. The use case describes the exact behavior of the systems and their  
544 interactions, which have major influences on developing interoperable energy systems.

545 Use cases provide a basis for identifying a system, its functionality, actors, interaction and interfaces.  
546 Functional and non-functional requirements can be developed and specified with the help of use case  
547 descriptions. Furthermore a use case provides a basis for defining test cases and test profiles for  
548 conformance testing and interoperability testing. And it also serves as the basis for acceptance testing.

549 IEC/PAS 62559 developed a use case based approach for designing energy systems. The SG-CG/SP  
550 (Smart Grid Coordination Group – Sustainable Process) adapted and tailored the use case template for its  
551 purpose. Based on these outcomes, IEC Technical Committee TC 8 decided to transform IEC/PAS 62559  
552 into a new IEC 62559 with four sub parts. IEC 62559-1 describes use case based approach for  
553 standardization. IEC 62559-2 specifies templates for use cases, actor list and requirement list. IEC 62559-3  
554 provides the definition of use case template artifacts into an XML serialized format in order to exchange use  
555 cases between different use case repositories or with UML engineering tools. The former IEC/PAS 62559 will  
556 be moved into IEC 62559-4.

557 Detailed processes, templates and examples of use case identification, creation and selection can be found  
558 in IEC 62559 relevant parts and in [SG-CG/K] [SG-CG/E]. From an interoperability point of view, the  
559 following points should be considered during the use case process:

- 560 • Review and validation of the use case narrative.  
561 *Interoperability aspect:* to check whether the narrative is mapped to SGAM domain. Whether the high-  
562 level use case exists and is reused.
- 563 • Validation of key use case actors and roles.  
564 *Interoperability aspect:* the definition of actors and roles must be compliant with the Smart Grid standard  
565 definition (see system definition in SG-CG/FSS, SG-CG/RA, SG-CG/SP), so that these can be interpreted  
566 by all parties and vendors correctly and clearly.
- 567 • Discussion of scenarios or steps to be included with the use cases.  
568 *Interoperability aspect:* using the steps template from IEC 62559-2 and document interoperability  
569 characteristics. In the step description there should be a clear correlation between the narrative and

---

<sup>4</sup> A Cockburn "Writing effective use cases"

570 steps. The step description should focus on interactions and information flows between actors. All  
571 interactions and information flows should be compliant with the Smart Grid standard [SG-CG/SS] at the  
572 end (use case should be developed in iterative steps from simple to detailed, depending on the  
573 engineering aim). Standard interfaces and protocols should be used for information exchange between  
574 the systems. In SG-CG/SS, standards and protocols are available at information layer, communication  
575 layer and component layer.

576 • Requirements development based on use cases

577 *Interoperability aspect:* The SGAM use case mapping process from SG-CG/RA should be used here to  
578 select relevant standards, interfaces and protocols. Use cases describe the system functions. The  
579 process starts with business / functional layers (roles, processes and actors). The first step for mapping  
580 will be the identification of domains and zones, which are affected by the use cases. Outline the coverage  
581 of the use case in the Smart Grid plane (domains and zones) and distribute systems or components to  
582 appropriate locations in the Smart Grid plane. The development of component layer is to map the use  
583 case diagram (actors and systems) to a SGAM domain – zone diagram so that the physical setup of the  
584 systems in SGAM domain – zone diagram can be designed. For the information layer, it is important from  
585 the use case description to identify which data or information has to be exchanged between which  
586 components and functions. Based on the type of exchanged information, the corresponding data model  
587 standard from the SGAM domain – zone diagram can be then selected. After the mapping of the  
588 information layer is completed, the final step is to develop the communication layer. Based on the location  
589 of system in the SGAM domain – diagram, the communication protocol can be defined. SG-CG/FSS  
590 specified all relevant protocols and standards in the corresponding layers within the SGAM domain –  
591 zone diagram. More details with examples about the use case mapping process can be found in SG-  
592 CG/RA B.2.4.

593 Figure 9 puts a view on how the degree of operationalization increases from the artifacts which are mainly  
594 derived from the mandate. Roadmaps provided a starting point, where use cases and structured templates  
595 as well as certain key standards were added. This is what the Use Case Management Repository (UCMR),  
596 the IEC PAS 62559 and the SGAM models are about. Starting from that, it has to be implemented and  
597 assessed for success and costs. Meaningful models for indicating interoperability between components like  
598 the SGIMM, architecture development methods and frameworks like TOGAF, Use Case Blue Prints, SGAM  
599 functional models and other catalogues exist to put the work from M/490 onto an architectural and utility  
600 implementation level. For that, different steps have to be taken, based on the core aspects from the SGAM  
601 and UCMR.

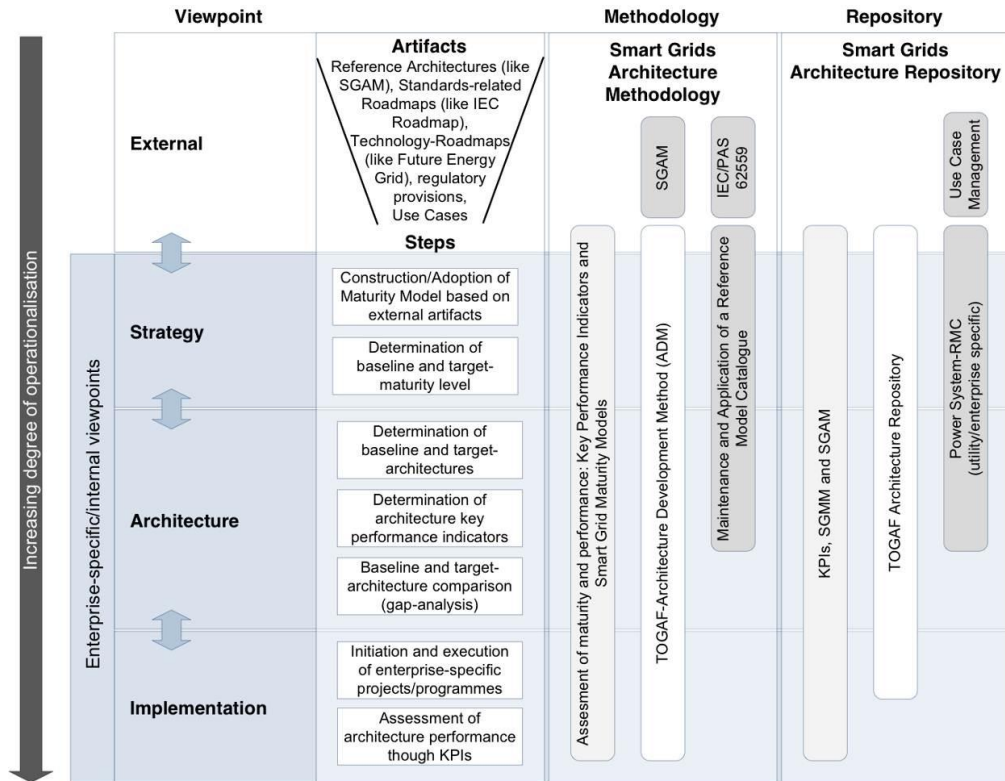

Figure 9<sup>5</sup> Creating an interoperable architecture from use cases

602

603

604

605

## 8. General methodology for profile definition

606

Interoperability (IOP) can generally apply between any layers with interfaces between Smart Grid objects that are required to fulfill a Use Case. This means that it first needs to be defined on which layers IOP is required for a given Use Case, and also in detail for each function.

607

608

609

Based on the SGAM layers, standards can be generally considered from a business or function layer perspective. Depending on the Use Case and as stated in the SG-CG/SS, this primarily applies to standards and specifications to be considered for interfacing objects within a system at:

610

611

612

- Business layer.
- Function layer.
- Information layer.
- Communication layer.
- Component layer.

613

614

615

616

617

618

The focus of this methodology is on function layer to reach IOP.

619

Profiles can be used to assist IOP. Profiles are documents that describe how standards or specifications are deployed to support the requirements of a particular Use Case or set of Use Cases. The WGI recommendation on the profile definition process is given in the following stages:

620

621

622

623

### a) Functional analysis

624

1. Select the applicable Use Case or set of use cases, as the use case and the related sequence diagrams could be considered sufficiently to define functional requirements. If no Use Case is available at this stage, it needs to be created first.

625

626

627

2. Define on which layers IOP is required to fulfill the functional requirements of a Use Case or set of use cases:

628

<sup>5</sup> Uslar, M., Specht, M., Dănekas, C., Trefke, J., Rohjans, S., Gonzalez, J., Rosinger, C., Bleiker, R. (2013): Standardization in Smart Grids: Introduction to IT-Related Methodologies, Architectures and Standards. Springer, Power Systems, 2013.

- 629 - Information layer.  
630 - Communication layer.  
631 - Component layer.

632

**633 b) Standards and specification selection**

- 634 3. Define required physical interfaces and communication channels between objects.  
635 4. Select (set of) standards for each interface within each required layer with IOP tool and also identify any  
636 gaps in conformance/compliance testing (or possibly IOP testing) in sets of standards. If necessary,  
637 specifications may be taken into account additionally.

638

**639 c) Profiling based on standards and specifications as identified above; the profile is based on  
640 business/functional requirements**

- 641 5. Build IOP profiles for each set of standards and specifications with possible feedback into  
642 standardization development.  
643 6. Apply profiles in system design and testing phases.  
644 7. Manage profiles.

645

**646 8.1 Standards & specification selection****647 8.1.1 Defining required physical interfaces and communication channels between objects**

648 As per definition an IOP profile is a document that describes how standards or specifications are deployed to  
649 support the requirements of a particular Use Case or set of Use Cases, it is therefore crucial to select the  
650 required standards or specifications as a prerequisite action for profile definition.

651 The relevant standards for different applications within each layer can be selected with the IOP tool (see  
652 section 10). It is therefore important that Use Cases are generally developed under application of the  
653 methodology and template of IEC 62559-2, and further processed according to the SGAM model including  
654 mapping of systems on the SGAM smart grid plane.

655

**656 8.1.2 Selection of standards using the IOP Tool**

657 The IOP Tool described in Section 10 helps to identify relevant standards by filtering for layers, systems and  
658 zones. The application of the IOP tool requires the conventions used to draw the component, communication  
659 and information layer of a system mapping according to SG-CG/FSS, or another adequate mapping  
660 description. This results in multiple sets of standards for each Use Case where all required standards within  
661 one set need to be interoperable and may require a specific IOP profile.

662 The selection of standards also needs to represent the requirements of the system design phase of the V-  
663 Model. Where appropriate, standards for

- 664 • Requirement analysis.  
665 • System design.  
666 • Architecture design.  
667 • Module design.

668 can be assessed with support of the IOP tool and the given filters. Backwards, the selected standards also  
669 need to be taken into consideration for the corresponding testing phases of the V-Model for compliance,  
670 conformance, IOP and acceptance tests.

671 How the selected standards are linked with profiles is part of the work item "IOP profiling" - see 8.2 below.

672 It is also important to note that the testing columns of the IOP tool only provide information where  
673 standardized requirements relating to conformance and IOP testing are already available for the listed  
674 standards. These are derived only to the wording and definitions of these standards and may substantially  
675 deviate from the definitions of the glossary in this report. WGI therefore strongly recommends that their



676 definitions should be considered and harmonized in future international standardization to create a common  
677 understanding.

678 Furthermore the list of testing is not comprehensive, but may generally support the identification of testing  
679 gaps.

680 The general methodology for the item “Standards & specification Selection” is demonstrated by way of the  
681 example Use Case “DER EMS and VPP system” (see section 8). In the absence of final Use Case  
682 descriptions according to IEC TC8, the generic Use Case examples from SG-CG/FSS serve as the basis in  
683 this methodology.

684

## 685 8.2 Profiles

### 686 8.2.1 Definition of a profile

687 A profile is a specification that governs information exchanged within a specific business exchange context.

688 Profiles can be developed to serve the information needs of specific user groups. These user groups can be  
689 diverse and can be characterized either by geographic context or by application domain. Examples of such  
690 user groups could be for instance: ‘European TSOs’ or ‘German DSOs’. Individual companies i.e. utilities or  
691 manufacturers can also develop their own profiles, as subsets of the more generic profiles of a user group  
692 but it is usually the aim to gain broad acceptance.

693 One of the most important purposes of a profile is to help ensure interoperability between systems. By  
694 adopting and implementing an accepted profile; one is, in a sense, entering into an informal agreement with  
695 entities that have adopted the same profile. Adopting a profile means increasing the possibilities for  
696 seamless information exchange and interoperability between systems. Open standards sometimes can be  
697 vague or have ambiguous specifications, the use of profiles can enforce one possible interpretation.

698 A *companion standard* is a concept that is closely related to a profile, but typically only refers to the base  
699 standard. An example of a companion specification is COSEM (Companion Specification for Energy  
700 Metering), which includes a set of specifications that defines the Transport and Application Layers of the  
701 DLMS protocol, or IEC 60870-5-104, a Companion Standard describing how the telecontrol standard IEC  
702 60870-5 is used over TCP/IP.

703

### 704 8.2.2 Profiling

705 In general, profiling within a standard and between standards and specifications helps to both improve  
706 interoperability and meet expectations of different projects where these will be implemented.

707 Out of this broad basis of international standards and specifications, specific subsets are implemented in  
708 products and systems.

709 Smart Grid applications can also differ, dependent on user type, region and philosophy. Stakeholders  
710 request guidelines and tools to improve interoperability in projects and therefore the challenge is to find a  
711 common concept/guideline to both improve interoperability and meet expectations of different projects.

712 To facilitate the goal of interoperability, a common understanding and interpretation of the related standard  
713 and the identical use of functional elements for required layers to fulfill application functions may be  
714 necessary. This can be achieved by defining profiles. They can be best provided by User Groups which are  
715 organizing themselves around smart grid key technology areas. A User Group consists of interested parties,  
716 e.g. companies, utilities, vendors, certification bodies, test labs, system integrators and regulators - see  
717 Figure 10.



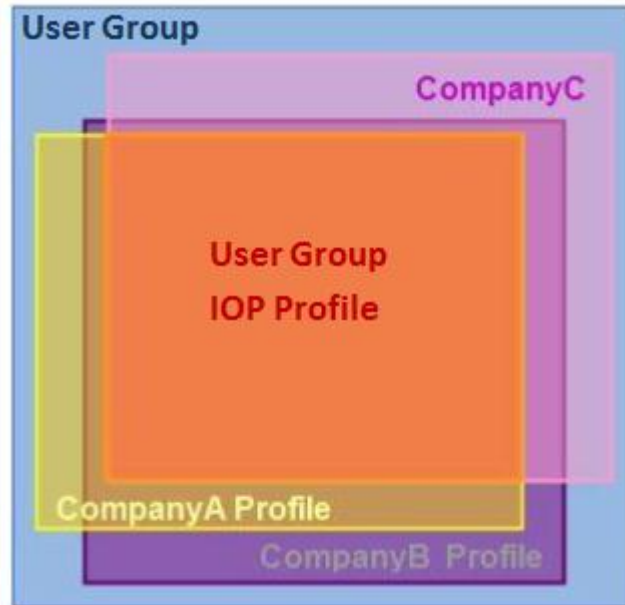

Figure 10 Companies collaborate in User Groups to create a common IOP profile

### 8.2.3 Creating a profile

The process to create a profile starts with a set of use cases, identifying a need for standardized interaction among a group of systems/applications to accomplish a business purpose. The driving force behind profile creation can either be the standardization organization itself, it can be a group of users that share a similar interest or application domain, or an individual company that requires interoperability of multiple systems in a specific application domain.

In most cases, such a user group will meet on regular intervals to discuss the scope/purpose of the business problem and to supply domain expertise to develop the technical specifications that will comprise the profile.

The process of developing and/or implementing a profile is in fact similar to that of developing a common standard. It will follow the process of requirement analysis and use-case development as described in section 7.1 and 7.2.

The resulting profile document can be presented for adoption to the larger user community and/or the standardization organization. In such a case, the resulting profile itself can become standardized. Successively, a test specification can be created for the profile and conformance testing against this test specification can take place. Conforming to a specific profile will increase interoperability of systems, as the scope of the functionality that is within the profile is narrower.

The profile definition methodology covers only a part of the overall process of defining business interoperability. It describes a methodology that begins with a canonical model and results in specifications for standardized exchange. Thus we are assuming here that the following steps have already been carried out:

- The business problem has already been analyzed to identify the functional exchanges that need to be standardized.
- The data requirements of each functional exchange have been identified.
- The canonical information model has been amended as necessary in order to be able to express all of the data requirements.

A fundamental requirement for the profile methodology is that it must produce a precise and testable specification of data exchanges among involved parties. When data is sent over the network, each party transmits data packets which include both header information and the actual data. The header identifies primarily the source and destination of the packet, while the actual data is referred to as the payload. Considering the lower OSI layers, the header information, or overhead data, is only used in the transmission process, and it is stripped from the packet when it reaches its destination. Therefore, the payload is the only data received by the destination system.

753  
754

An example of profile definition of higher OSI layer related to the IEC “Common Information Model” is shown in Figure 11.

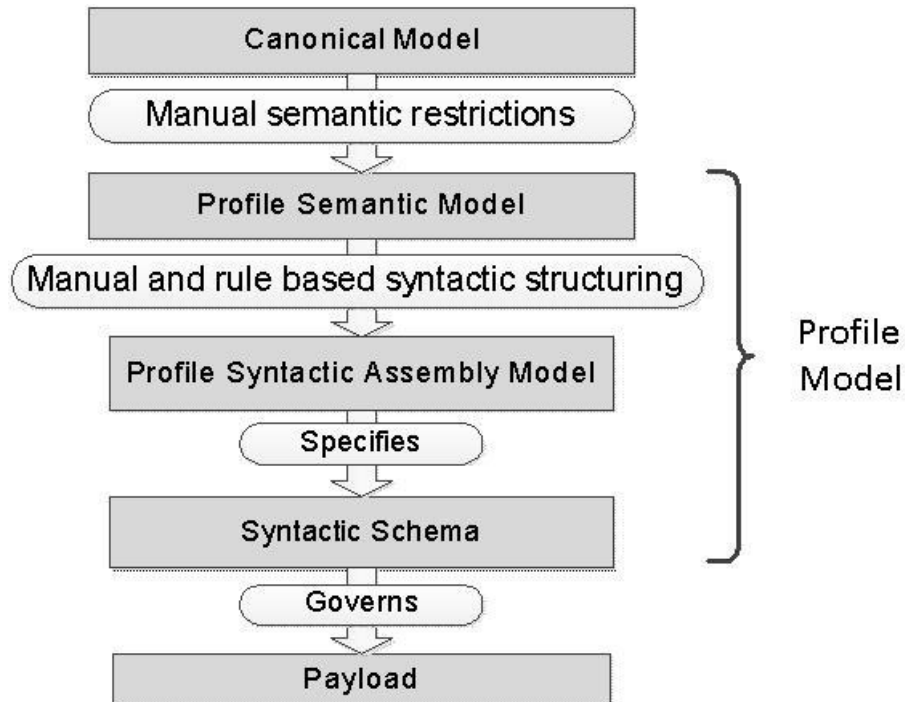

755  
756  
757

Figure 11 Method for payload Creation

758  
759  
760

The purpose of profile specification for a standard information exchange, is to provide all information that is required for a producer to create payload instances, for a consumer to interpret payload instances, and for an impartial party to judge compliance of a payload instances.

761

This requires two things, which are rigorously separated in this profiling methodology:

762  
763  
764

- A profile semantic model specifies the structural elements that capture the information content. This includes the names of data items and the relationship between named data items that make up the payload.

765  
766

- The syntactic model specifies how the semantic model is serialized so that it can be transferred from producer to consumer, where those parties may be in different computing environments.

767  
768  
769  
770

The WGI recommendation is that the layout, format, syntax and the structure of a created profile should be standardized to augment the application by different users in an unambiguous manner and so to simplify the complexity of the SGAM model based on its five interoperability layers. This should also apply for standardized test cases without adding further engineering steps for configuration and device settings.

771  
772

As the input provided by standards and specifications is based on documents, a profile may require additional features such as a machine-readable format, but it may at least contain the following features:

773  
774  
775  
776  
777  
778  
779  
780  
781

- Profile Name.
- Requirements, boundaries and scalability.
- Communication network topology (e.g. based on the component layer).
- List of systems and technologies where applicable.
- Standards and specifications.
- Security considerations.
- Configuration parameters.
- Best current practice approach.

782  
783  
784

To find the most appropriate solution, an international standardization endeavor should be established which may be similar to the standardization of use cases according to IEC PAS 62559. This also ensures that all interested parties may equally contribute to the process.

785

786 **8.3 Basic Application Profiles (BAP)**

787 A Basic Application Profile (BAP) basically applies to the design phase of the V-Model and is based on  
788 system/subsystem specific basic application functions descriptions.

789 The term “basic” means in this context, that it is recommended to decompose an application function into  
790 elementary (basic) parts which should be the base for defining application profiles.

791 A BAP is an agreed-upon selection and interpretation of relevant parts of the applicable standards and  
792 specifications and is intended to be used as building blocks for interoperable user/project specifications.

793 The key ideas of BAPs are:

- 794 • BAPs are elements in a modular framework for specific application systems/subsystems.
- 795 • Combinations of different BAPs are used in real projects as building blocks.
- 796 • Project specific refinement additional to the BAP might be necessary to meet specific requirements for  
797 implementation in projects. These additional requirements should be frequently fed back into the User  
798 Group and may lead to a new or revised BAP based on user experiences and group decisions.

799 BAPs are valid for specific application systems/subsystems (e.g. Substation automation, DER management,  
800 hydro power and storage). They are intended to represent a user agreed common denominator of a  
801 recommended implementation or a proven best practice implementation of an application function in a  
802 specific smart grid system/subsystem, but they are not aimed to cover all possible implementation options.

803 BAPs **must** not have options; all selected criteria are therefore mandatory in the interest of interoperability. If  
804 variants of BAPs for an application function are needed, different BAPs for the same application function  
805 have to be defined to reach the required level of interoperability.

806 BAPs are built on the basis of international standards and also may have an influence in the further  
807 development of standards by possible feedback and implementation of lessons learned. Figure 12 shows  
808 BAPs in the workflow of a standardization process.

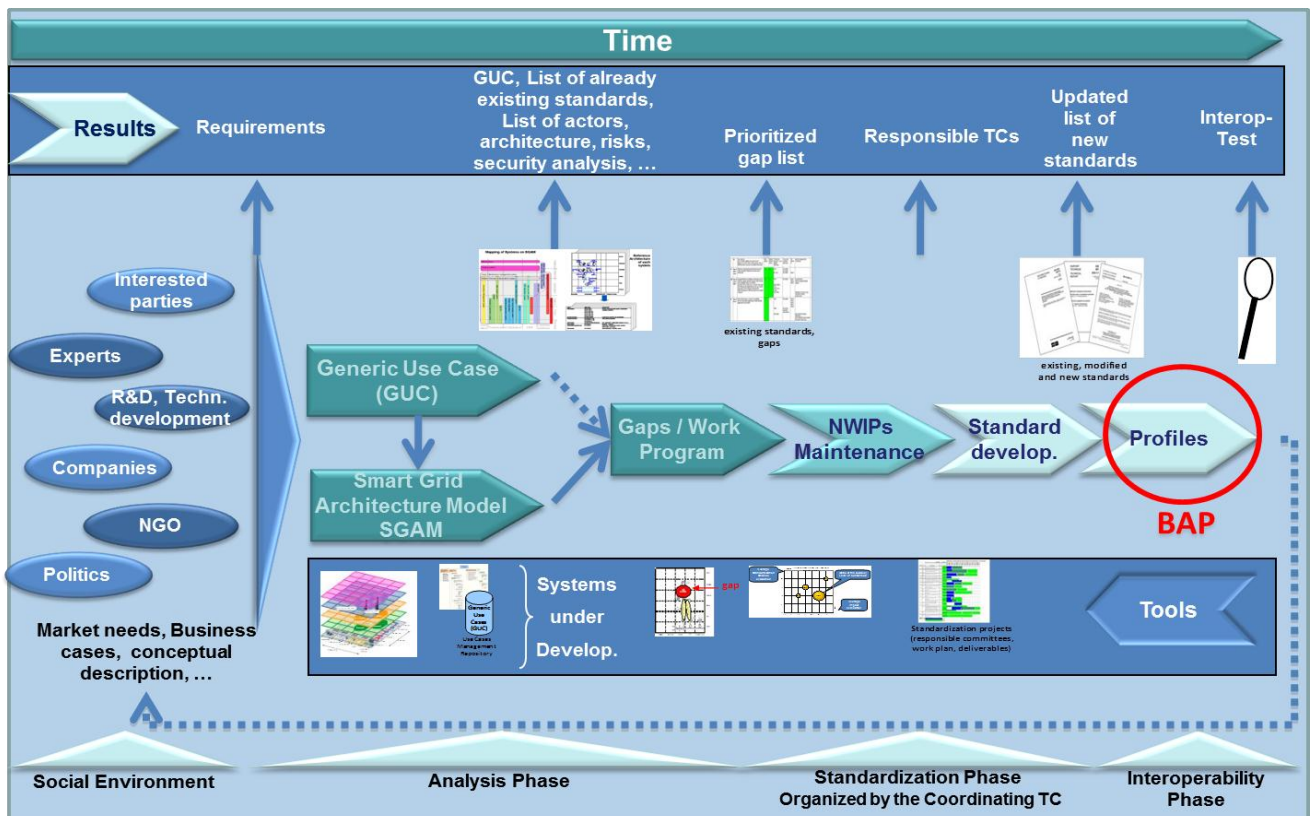

809

810

811

812 BAPs may include:

- 813 • Description of the related application function (SGAM function layer).

- 814
- 815
- 816
- 817
- 818
- Relevant data models (SGAM Information Layer).
  - Communication services (SGAM Communication Layer).
  - Component related requirements (SGAM Component Layer).
  - Interaction diagrams if the application function is divided into sub-functions which may be distributed in different physical devices.

819 BAPs do not include more than “black box” functional behavior specification, algorithms, functional code and  
820 detailed instance definitions.

821

822 **8.4 Interoperability profile (IOP)**

823 As defined in the glossary an IOP profile is a document that describes how standards or specifications are  
824 deployed to support the requirements of a particular application, function, community, or context. A profile  
825 defines a subset of an entity (e.g. standard, model, rules). It may contain a selection of data models and  
826 services as well as a protocol mapping. Furthermore a profile may define Instances (e.g. specific device  
827 types) and procedures (e.g. programmable logics, message sequences).

828 The objective of profiles is to reduce complexity, clarify vague or ambiguous specifications and so aims to  
829 improve interoperability. These do generally apply for both sides of the V-Model in terms of Basic Application  
830 Profiles (BAP) for the design phase and as extended versions (see BAIOP below) in the testing phase as  
831 shown in Figure 13.

832

833 **8.5 Basic Application Interoperability Profile (BAIOP)**

834 To assist interoperability a BAP can be extended to interoperability testing. The extended BAP is referred to  
835 as Basic Application Interoperability Profile (BAIOP).

836 For interoperability testing a BAP has to be extended by:

- 837
- 838
- 839
- 840
- 841
- 842
- 843
- Device configuration.
  - Test configuration with communication infrastructure (topology).
  - BAP related test cases.
  - Specific capability descriptions (e.g. PICS, PIXIT, MICS in case of IEC 61850).
  - Engineering framework for data modeling (instances) and communication infrastructure (topology, communication service mapping).

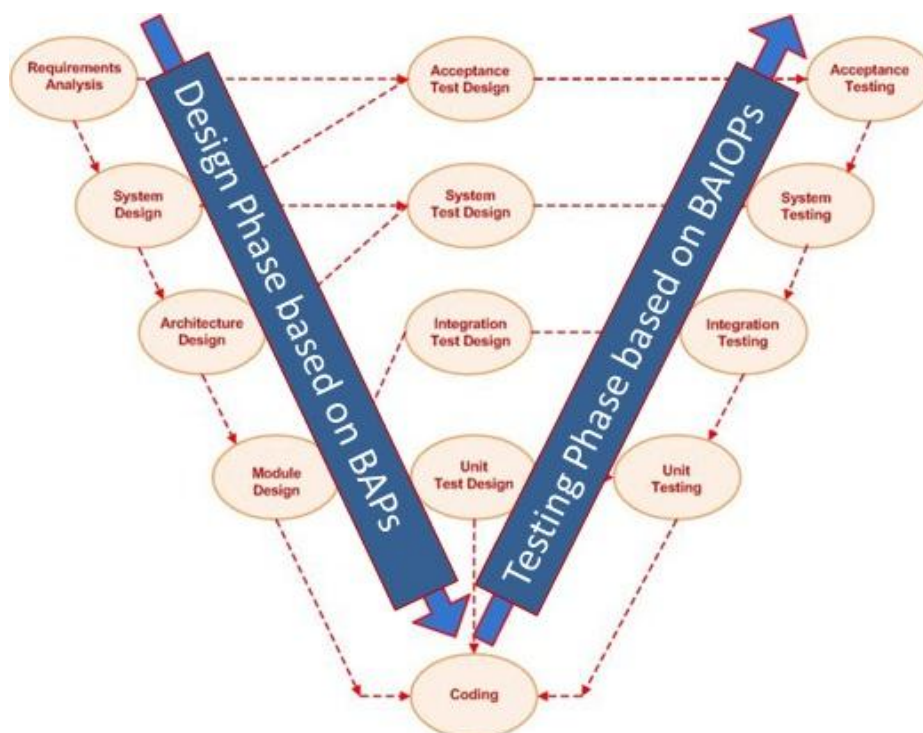

844

845

Figure 13 V-Model including BAP and BAIOP



846

847 The definition and common use of BAPs and BAIOPS should lead to a win-win situation for all stakeholders  
848 involved in a smart grid project in general, e.g.:

- 849 • The benefit for customers (e.g. utilities) and User Groups is the chance to harmonize the various  
850 company specific application function variants to a common denominator / best practice implementation  
851 for each basic application function. This reduces the risk of interoperability problems caused by  
852 products/systems as these may be selected from standardized BAP frameworks and tested according to  
853 BAIOPS.
- 854 • The benefit for vendors which will use standardized BAPs in their products is the reduction of project  
855 specific or customer specific implementation variants of application functions and therefore reduce  
856 product complexity, development costs and parameterization efforts. BAIOPS can be used for internal  
857 tests before the product is placed on the market.
- 858 • The benefit for Certification Bodies / Test Labs is the ability to perform interoperability tests based on  
859 BAIOPS on behalf of users.
- 860 • The benefit for system integrators is that they can specifically select products conformant with BAPs and  
861 tested according to BAIOPS. This should reduce the efforts for integration of subsystems or devices.  
862

863 **8.6 Process from a Use Case to Interoperability on SGAM function layers**

864 Figure 14 illustrates the process from a Use Case to Interoperability on SGAM function layers by using BAPs  
865 and BAIOPS.

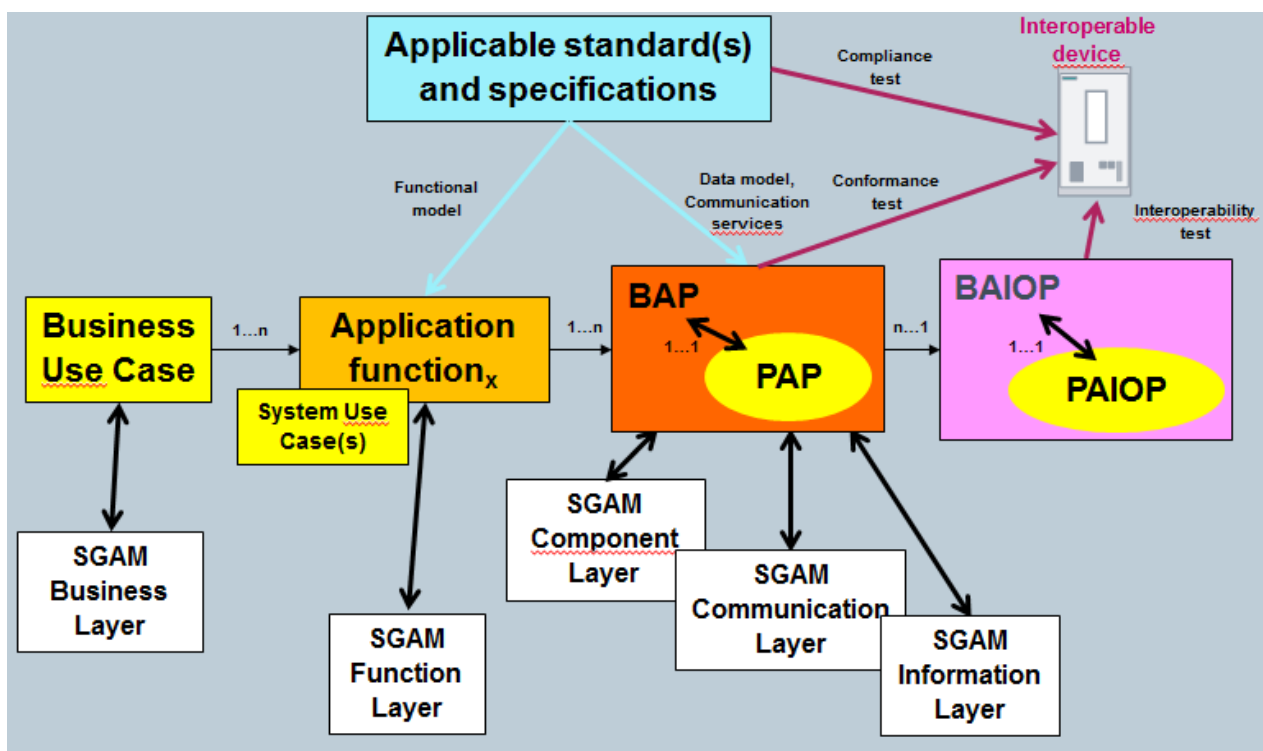

866

867 **Figure 14 Process from Use Case to Interoperability on SGAM layers**

868

869 Although not entirely consistent with the thinking in this report regarding interoperability and  
870 interchangeability, it may be useful to consider the device compatibility levels derived from TC65/920/DC  
871 which are shown in Figure 15. With an increased required level of compatibility towards IOP, the necessary  
872 device features that need to be covered by profiles are also increasing.

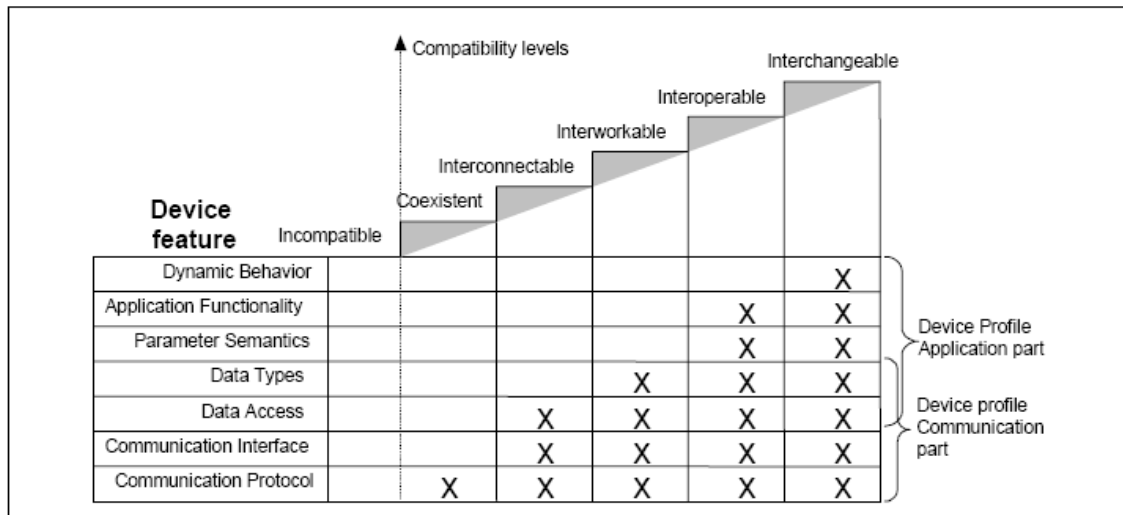

Figure 15 Device features covered by profiles depending on compatibility levels acc. to TC65

873

874

875

876 The general methodology for the item “Profiling” is demonstrated by way of the example Use Case “DER  
877 operation system” (see annex 12.6).

878

### 879 8.7 Managing profiles

880 It is important that profiling management is in place in order to ensure that profiles are applied and  
881 understood in the same way by all affected stakeholders, and to avoid that no diverging profiles for the same  
882 purpose are developed and applied in parallel. This mainly includes:

- 883 • the responsibilities and roles of the different actors which are involved to create and manage profiles.
- 884 • change management and versioning control of updated profiles.
- 885 • communication of changes to affected stakeholders.

886 Therefore the general WGI recommendation is that User Groups should take ownership of creating and  
887 managing profiles. This also means that lessons learned should be fed back by users of the profiles to the  
888 corresponding User Groups that these are able to improve their profiles according to predefined cycles. This  
889 also implies that adequate backwards-compatibility should be implemented within this process. Therefore  
890 clear contact information should be attached to profiles. The User Group should be also responsible for the  
891 change management and versioning control of updated profiles, and to communicate changes to the  
892 affected stakeholder and other User Groups in an adequate way, e.g. by newsletters or information on User  
893 Group websites.

894

### 895 8.8 Implementation of profiles in real projects

896 As afore mentioned, BAPs and BAIOPs are elements in a modular framework for specific application  
897 systems/subsystems and can be used in combination as building blocks in real projects. The user involved in  
898 the project (e.g. a company or system integrator) is responsible for developing and maintaining Project  
899 Application Profiles (PAP) and Project Application Interoperability Profiles (PAIOP) based on these building  
900 blocks, but specific refinement still might be necessary to meet project requirements. The user should also  
901 feedback his experiences, implementation and options back to the corresponding User Groups which may  
902 lead to a revision of the original BAPs and BAIOPs.

903 To reduce the project implementation efforts, it is desired that PAPs and PAIOPs consist of BAPs and  
904 BAIOPs to the highest possible extent, so that as little refinement as possible needs to be performed by the  
905 user.

906 As the execution of a project may take longer time in some cases, a regular check of updated BAPs and  
907 BAIOPs should be performed by the user which may also lead to the revision and implementation of revised  
908 PAPs and PAIOPs within the project. It is therefore recommended to use only the latest profiles as building  
909 blocks to improve interoperability.

910 Figure 16 illustrates this process.

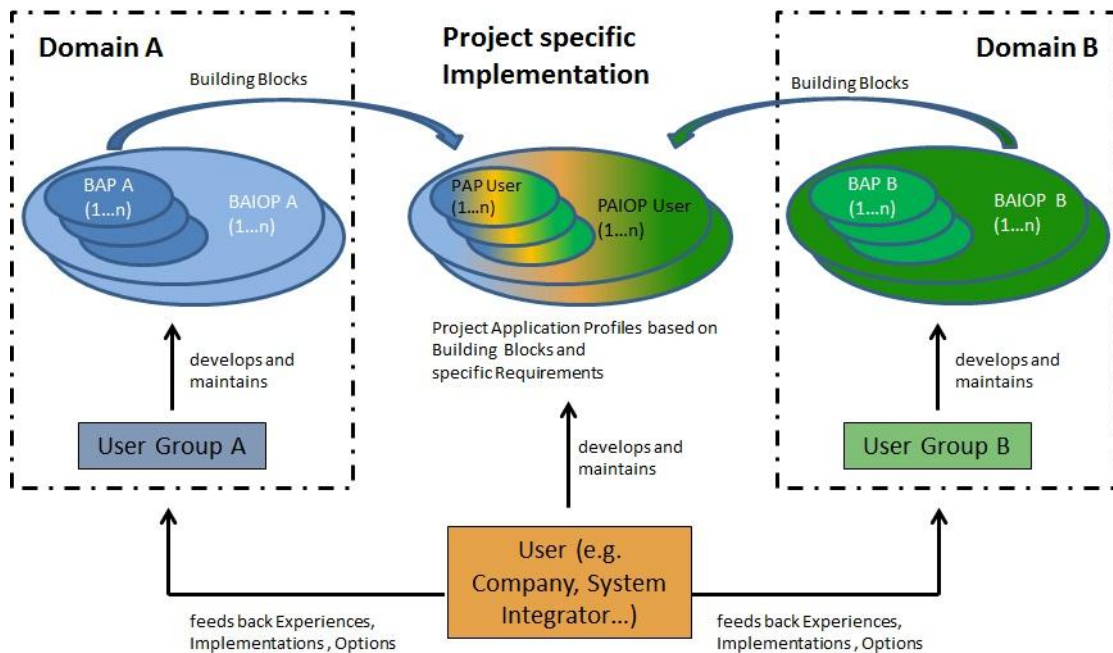

911

912

**Figure 16 Workflow of project specific profiling**

913 **8.9 Experiences of creating BAPs using the process from Use Case to Interoperability**

914 This section contains an experience and example of creating BAPs using the process from Use Case to  
 915 Interoperability. We will only mention here the main experiences and most important or illustrative examples.  
 916 Other experiences and examples are available in the annexes 12.3 to 12.8.

917

918 **8.9.1 Experiences of creating BAPs from the in EU FP7 project COTEVOS**

919 In annex 12.5: Example and experiences of BAPs and BAIOPs in EU FP7 project COTEVOS, the first  
 920 preliminary results with the interoperability method of this document are described. COTEVOS is an EU FP7  
 921 project that focusses on testing eMobility systems and their Interoperability with Smart Grids.

922 As described in Figure 14: "Process from a Use Case to Interoperability on SGAM function layer" the starting  
 923 point are use cases. Since COTEVOS focus is on eMobility systems, the first two use cases used are the  
 924 use case WGSP-1300 Smart (re- / de) charging and use case WGSP-1400 Ensuring interoperability and  
 925 settlement.

926 The first step is mapping the actors of the system, as described in the use case, on the COTEVOS  
 927 Reference Architecture. This mapping on SGAM business layer is straightforward and easy since the use  
 928 cases clearly define actors and a complete architecture is available (for details see annex 12.5).

929 The next step is defining the required functions based on the step by step analysis already described in the  
 930 use case. To identify the application functions from the use case is quite some work, but not a complex task.  
 931 As described in the process in Figure 14 in this stage already some possible standards can be identified  
 932 when they relate to the information exchanged by the functions.

933 The third step is mapping these functions and their information flows on the system from the actors and other  
 934 physical components; this results in Figure 17.

935



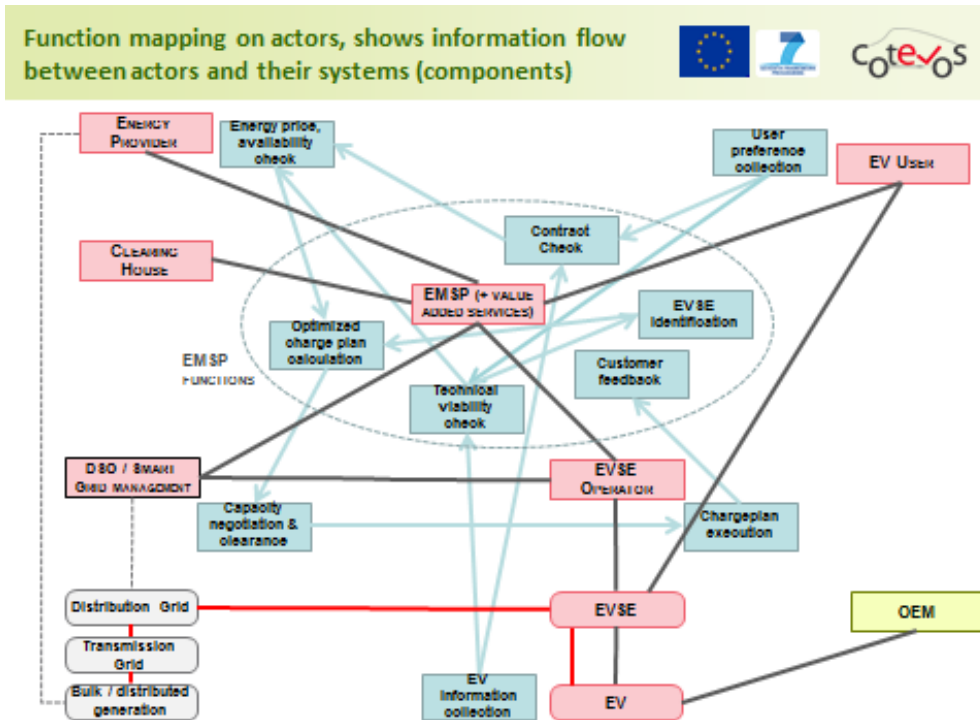

Figure 17 Function mapping on actors and components with information flows

Now the required information flows and interfaces between components and systems are clear, information flows can be combined when they are exchanged between same components or systems in the architecture. This leads to 5 communication interfaces required for the Smart Charging use case as made visible in the Figure 18.

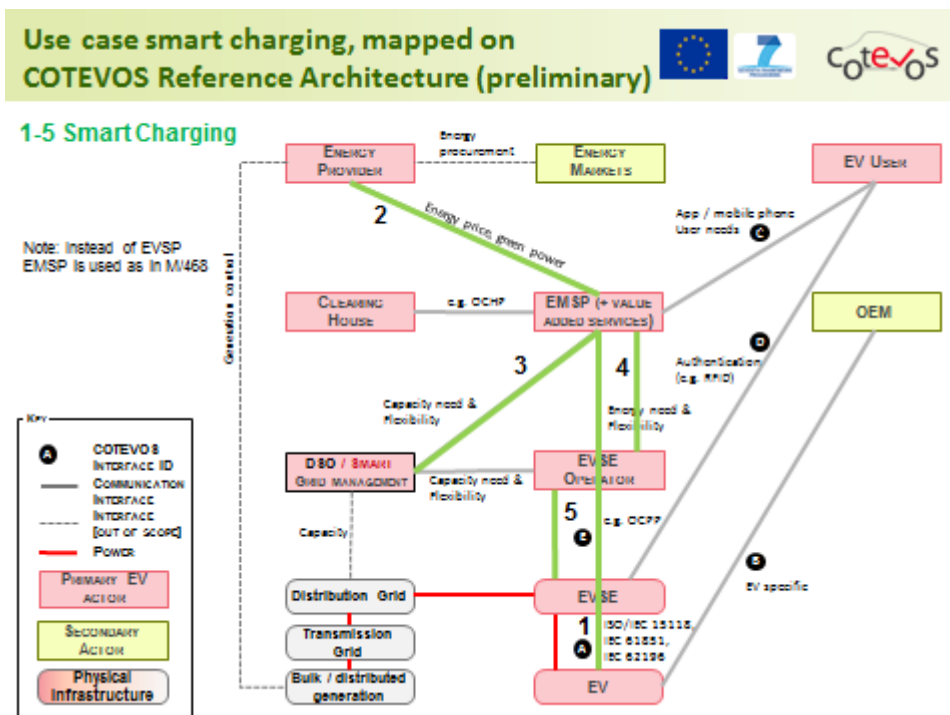

Figure 18 Use case smart charging mapped on COTEVOS Reference Architecture

This is enough material to start creating one or more BAPs. It would be possible to create one BAP out of this complete use case, but that would lead to as many BAPs as use cases, also any alternatives in interfaces lead to a complete new BAP (there cannot be alternatives/choices inside BAPs). Also as defined BAPs can be used as building blocks ("Combinations of different BAPs are used in real projects as building

949 blocks”), therefore (in this case) the best option is to create a BAP per information flow. This first use case  
950 leads to 5 different BAPs.

951 A second use case on Authentication and Roaming (WGSP-1400) has been worked out in the same way. In  
952 itself this use case would also lead to 5 BAPs, but three of them can be combined with one of the BAPs of  
953 the previous use case. So in total with only 7 BAPs we can cover these 2 use cases. Additional use cases  
954 will mostly not lead to new BAPs since an extension of the information layer of the BAP is enough if the  
955 interface used is the same.

956 For more details on this example refer to annex 12.5: Example and experiences of BAPs and BAIOPs in EU  
957 FP7 project COTEVOS.

958

## 959 9. Testing

### 960 9.1 Testing according to the V-Model

961 Testing is one of the most important phases of the system or software development life cycle. The V-Model  
962 in Figure 13 represents a system or software development process which was first proposed in the late  
963 1980s and is still in use today. It is also applicable to hardware development. It demonstrates the  
964 relationships between each phase of the development life cycle and its associated phase of testing.

965 The BAIOP defines e.g. the detailed test cases and the system configuration, test configuration, specific  
966 capabilities of the system etc. While the key stakeholders in developing and maintaining a BAP are the  
967 utilities and standardization bodies, the key stakeholders for the BAIOP are the certification bodies and test  
968 laboratories.

969 In some cases, compliance testing for the relevant unit can be performed during the unit testing phase to  
970 make sure that the standalone unit is complying with the standards. In case of a conformance test according  
971 to a specific profile, the BAIOP can be used to define the test cases and configuration of the specific stand-  
972 alone unit and verify if the stand alone units are conformant with the specification (BAP).

973 This test will normally be carried out by the manufacturer.

974

### 975 9.2 Unit testing (software)

976 A unit is the smallest testable part of an application. In procedural programming a unit may be an individual  
977 function or procedure. In our scope a unit also could be considered equivalent to a system or device. Unit  
978 testing focuses on each component individually. Unit tests are created by programmers or occasionally by  
979 white box testers. The purpose is to verify the internal logic code by testing every possible branch within the  
980 function, also known as test coverage.

981

### 982 9.3 Unit testing/prototype testing (hardware)

983 A unit is the smallest testable part of an application. In our scope a unit could be considered as a single  
984 device. Prototype testing focuses on each component individually. Prototype tests are created by white box  
985 testers. The purpose is to verify the internal operations by testing every electrical and/or mechanical process  
986 within the particular component.

987 In some cases, conformance testing of the relevant unit can be performed during the prototype testing phase  
988 to make sure that the standalone unit is conforming to the standards or specification.

989 This test will normally be carried out by the manufacturer.

990

### 991 9.4 Integration testing

992 In integration testing separate units (systems, devices) will be tested together to expose faults in the  
993 interfaces and in the interaction between integrated components. Integration testing can validate the system  
994 interoperability at the relevant SGAM layers.

#### 995 **Software:**

996 Testing is usually black box as the code is not directly checked for errors.

#### 997 **Hardware:**

998 Integration testing of hardware is the testing of one device of the type series (prototype) in the field with a  
999 connection to the grid and the interconnection to other typical devices (interoperability).

1000 This test will normally be operated by the manufacturer in the first instance. In the second instance the test  
1001 could be performed by an accredited test lab or an independent certification body on the behalf of users.

1002 During profile definition the BAP is developed specifically for this test phase. As a result the BAIOP can be  
1003 developed to specify the detailed test cases, system configuration and test configuration.

1004

## 1005 9.5 System testing

1006 The system test is still a test of one device of the type series (prototype test) but for a specific market or  
1007 application.

1008 System testing is conducted on a complete, integrated system to check if the integrated product meets the  
1009 specified requirements. It looks at the system from the perspective of the customer and the future user. The  
1010 system test requires no knowledge of the inner design of the code or logic.

1011 The conformance of the device according to the specified grid requirements must be able to be proved by an  
1012 independent party. System testing can be used to validate a model for the electrical behavior of the device.  
1013 The model can be used for a further simulation in the project level.

1014

## 1015 9.6 Acceptance Testing

1016 Acceptance testing means customer agreed tests of the specifically manufactured system installation or its  
1017 parts.

1018 The Factory Acceptance Test (FAT) takes place before installation of the concerned equipment. Most of the  
1019 time testers not only check if the equipment meets the pre-set specifications, but also if the equipment is fully  
1020 functional. A FAT usually includes a check of completeness, verification against contractual requirements, a  
1021 proof of functionality (either by simulation or a conventional function test) and a final inspection. The results  
1022 of these tests give confidence to the client(s) as to how the system will perform in production. There may  
1023 also be legal or contractual requirements for acceptance of the system.

1024 The Site Acceptance Test (SAT) in the implementation phase takes place at the customer's location and is  
1025 commonly the final test before the equipment will be handed over to the customer. Ideally a FAT has been  
1026 taken place before at the manufacturer's location. If issues are found in acceptance testing which are caused  
1027 by field experiences the original author of the profile must adapt the profile.

1028 This test will normally be carried out by the manufacturer, client and grid operator. Often an independent  
1029 third party is involved.

1030

## 1031 9.7 Testing to achieve interoperability

1032 This section investigates how interoperability can be demonstrated through testing. The main purpose of  
1033 testing by a system integrator or asset owner / operator is to verify and validate the design, components and  
1034 architecture of the solution against a set of requirements. The aim should be to develop an evidence  
1035 procedure, with which the proof of conduct is laid down uniformly. A model which can be utilized for this  
1036 purpose is the German technical specification for electrical characteristics for power generating units and  
1037 systems for medium and high voltage grids<sup>6</sup>. This is a two-step process to confirm the conformity of power  
1038 generating plants according to the guidelines. Although many other types of tests exist as described in the  
1039 previous chapter, the two main types of testing to demonstrate interoperability are:

### 1040 • Conformance Testing

1041 Determines whether an implementation conforms to the profile as written, usually by exercising the  
1042 implementation with a test tool. This is likely to be the most common type of testing program;

### 1043 • Interoperability Testing

1044 Connects two or more implementations together and determines whether they can successfully  
1045 interoperate. It is significantly different from conformance testing because it is often possible for two  
1046 systems that comply to a standard to be unable to interoperate. These situations can arise because they  
1047 have chosen different or conflicting options within the standard or because the implementations have  
1048 conflicting interpretations of the specification.

---

<sup>6</sup> Technical Guidelines for Power Generating Units and Farms; Part 8 "Certification of the Electrical Characteristics of Power Generating Units and Farms in the Medium-, High- and Highest-voltage Grids" published by FGW e.V. (Fördergesellschaft Windenergie und andere Erneuerbare Energien). Preview: [http://www.wind-fgw.de/pdf/TG\\_Part8\\_Rev6\\_EN\\_preview.pdf](http://www.wind-fgw.de/pdf/TG_Part8_Rev6_EN_preview.pdf).

1049  
1050  
1051  
  
1052  
1053  
1054  
1055  
  
1056  
1057  
  
1058

The quality of the resulting interoperability of the Smart Grid system increases with each additional type of testing performed. During the test, practical experiences can be collected and valuable feedback can be given to the standards, so that standards can be improved and extended.

A generic methodology for conformance and interoperability testing is described in detail in ETSI EG 202 798 which shows as well how this methodology is applied to other technologies such as Intelligent Transport Systems domain. An outline of this methodology is provided in the next clauses (9.7.2 and 9.7.3) for both conformance and interoperability testing.

Based on that generic methodology, Figure 19 illustrates how it is applied to Smart Grid and the interactions between Smart Grid base standards and Smart Grid test specifications.

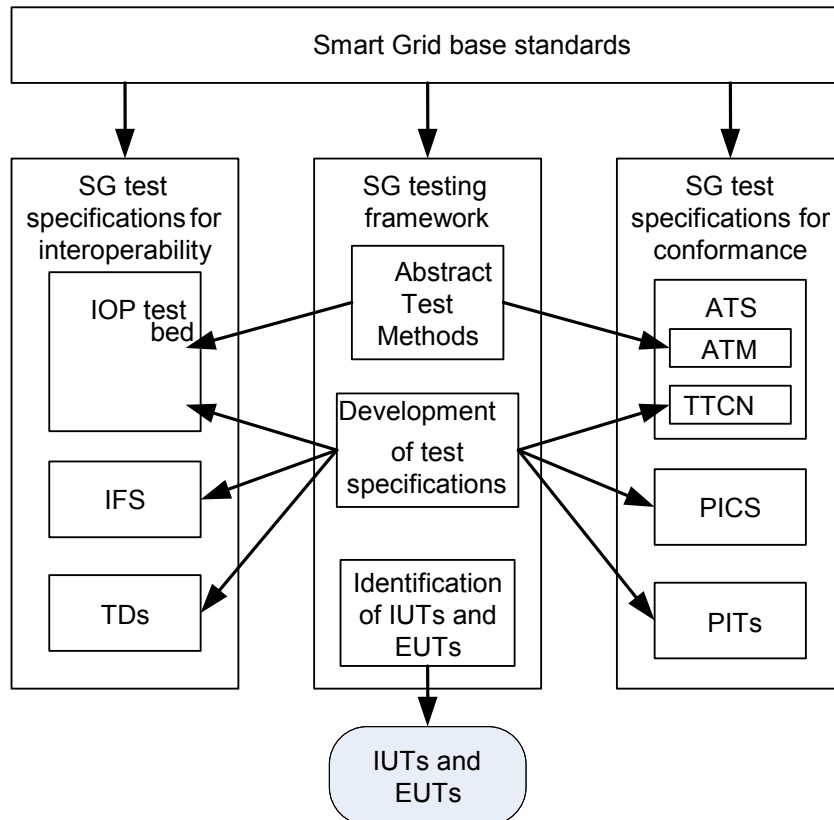

1059  
1060  
1061  
1062

Figure 19 Creating an interoperable architecture from use cases <sup>7 8</sup>

### 9.7.1 Testing and Test Control Notation version 3

1063  
1064  
1065  
1066

TTCN-3 is a test specification language that applies to a variety of application domains and types of testing. It has been used since 2000 in standardization as well as in industry, research, international projects and academia. In response to the demands of the user community TTCN-3 is being continuously improved and extended.

1067  
1068  
1069  
1070

TTCN-3 provides all the constructs and features necessary for black box testing. It embodies a rich typing system and powerful matching mechanisms, support for both message-based and procedure-based communication, timer handling, dynamic test configuration including concurrent test behavior, the concept of verdicts and verdict resolution and much more.

1071  
1072  
1073  
1074

As a result of its intrinsic extensibility, TTCN-3 is able to import external data and type specifications directly and external implementations can be integrated in order to extend the functionality specified in the TTCN-3 standards. Several mappings of external data and type specifications such as ASN.1, IDL and XML are already standardized. Others can easily be added.

<sup>7</sup> PICS (Protocol Implementation Conformance statements) is equivalent to the "Protocol Profile"

<sup>8</sup> IFS (Interoperable Functions Statements) is equivalent to "Functional Profile"

1075 A TTCN-3 documentation notation based on embedded tags is also standardized in ES 201 873-10.

1076 The abstract definition of test cases which is fundamental to TTCN-3 makes it possible to specify a non-  
 1077 proprietary test system which is independent of both platform and operating system. The abstract definitions  
 1078 can be either compiled or interpreted for execution.

1079 The TTCN-3 reference architecture defines standardized interfaces for test control for encoding and  
 1080 decoding of data and for test execution.

1081

1082 **9.7.2 Conformance testing**

1083 Conformance testing is used to verify that an implementation or system conforms to the established  
 1084 specifications or profiles. Conformance testing means that a specific implementation is compared to the  
 1085 companion specification/profile to be sure that the implementation does what is specified.

1086 The terms conformance testing and compliance testing are loosely used across industry generally with  
 1087 slightly different intents and meanings. In both cases, the terms refer to testing a system or device against a  
 1088 defined set of criteria, and evaluating the test results against the metrics defined within the criteria. Generally  
 1089 conformance tests are executed to test an implementation or system using a dedicated test system (see  
 1090 Figure 20).<sup>9</sup>

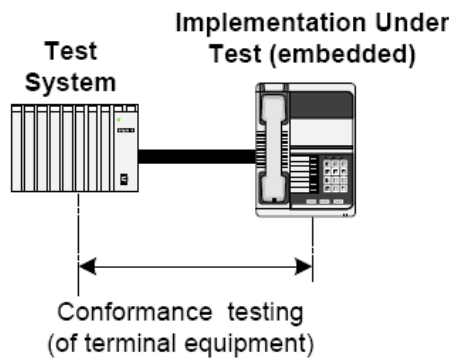

1091 **Figure 20 conformance testing**

1092

1093

1094

1095 The definition of conformance is dependent on the system or device implementation against the specified requirements.

1096 Conformance or compliance with the criteria implies a passing or successful result. The term conformance is  
 1097 more widely used and generally associated with testing programs that are of a voluntary or market driven  
 1098 nature. The term compliance is more closely associated with mandatory or regulatory oriented programs.

1099 Conformance testing can take place against the core standard and/or against the conformance test profiles  
 1100 that have been defined on top of the standard.

1101 A typical procedure for conformance testing includes:

- 1102 • Identification of candidate "Implementations Under Test" (IUT) see Figure 20.
- 1103 • The "Implementation Under Test" (IUT) is a protocol implementation considered as an object for testing.
  - 1104 - This means that the test process will focus on verifying the compliance of this implementation (IUT)
  - 1105 with requirements set up in the related base standard. An IUT normally is implemented in a "System
  - 1106 Under Test" (SUT). For testing, an SUT is connected to a test system over at least a single interface
  - 1107 specified in the relevant base standard. Such an interface is identified as "Reference Point" (RP).
- 1108 • Identification of reference points.
  - 1109 - Reference points are interfaces where test systems can be connected in order to test conformance of
  - 1110 IUTs with base standards.
- 1111 • Identification of the Abstract Test Method (ATM) as defined in ISO 9646-1.

<sup>9</sup> source ETSI whitepaper for conformance testing and interoperability testing



- 1112 - abstract protocol tester. It is a process providing the test behavior for testing an IUT. Thus it will
- 1113 emulate a peer IUT of the same layer/the same entity.
- 1114 - functional TTCN-3 test architecture. This illustrates how to implement the abstract test architecture
- 1115 defined in the abstract protocol tester in a functional test environment. There are many possibilities to
- 1116 implement this abstract test architecture using different types of programming languages and test
- 1117 devices. ETSI testing frameworks use TTCN-3 being a standardized testing methodology including a
- 1118 standardized testing language, which is fully compliant with the ISO 9646 abstract test methodology.
- 1119 • Development of conformance test specifications.
  - 1120 - Developing "Implementation Conformance Statements" (ICS) from base standards, if not already
  - 1121 provided as part of the base standard.
  - 1122 - Developing "Test Suite Structure and Test Purposes" (TSS&TP) from ICS and base standards.
  - 1123 - Developing TTCN-3 test suite, e.g. naming conventions, code documentation, test case structure.

### 1125 9.7.3 Interoperability testing

1126 Interoperability testing is a procedure in which two or more implementations (systems, products) are tested in  
 1127 combination with each other, with the standard/profile used primarily as a reference to judge problems and  
 1128 incompatibilities and secondarily as a guide to the functions that should be tested and the general behavior  
 1129 to be expected (Preston & Lynch, 1994). Interoperability testing may be viewed as a supplement to (the next  
 1130 step after) conformance testing, by verifying that diverse implementations do indeed work together effectively  
 1131 and interoperate, to deliver the expected results. Devices/systems in the interoperability test should be tested  
 1132 according the same profile (or interoperability test profile).

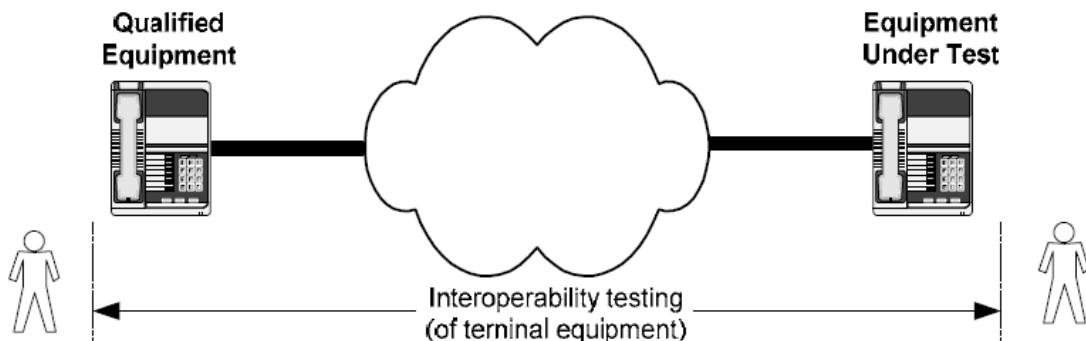

1134 **Figure 21 Interoperability testing**

1137 Typically, a test specification is composed, which will contain the specific test cases to be run to verify  
 1138 interoperability.

1139 Beyond the ability of two or more systems to exchange information, semantic interoperability is the ability to  
 1140 automatically interpret the information exchanged meaningfully and accurately in order to produce useful  
 1141 results as defined by both systems. To achieve semantic interoperability, both sides must refer to a common  
 1142 information exchange reference model. The content of the information exchange requests are  
 1143 unambiguously defined: what is sent is the same as what is understood.

1144 Interoperability of Smart Grid systems and devices is a high priority goal cited across many organizations,  
 1145 driving the efforts to enhance our energy infrastructure. System and device testing is a critical foundational  
 1146 issue for Smart Grid deployment. The stakes are high to assure that deployed technology has been  
 1147 rigorously tested to assure that requirements are met and systems interoperate as advertised.

1148 Interoperability Events (IOP events, sometimes also referred to as plugfests, test events, plugtests and other  
 1149 names) are usually vendor driven activities where multiple vendors come together to demonstrate specific  
 1150 interoperability functions. These events are highly useful in product development and new standards  
 1151 implementation, but are often limited in their value as a definitive demonstration of product readiness for  
 1152 deployment. IOPs can be thought of as early interoperability testing programs and may also play an  
 1153 important role in the development of formalized industry test programs.



1154 A typical procedure for interoperability testing includes:

- 1155 • Identification of candidate "Equipment Under Test" (EUT).
  - 1156 - For interoperability testing, only "Equipment Under Test" (EUT) is considered. An EUT is a physical
  - 1157 implementation of an equipment that interacts with one or several other EUTs via one or more RPs;
- 1158 • Identification of test scenarios.
  - 1159 - In order to perform interoperability tests, EUTs supporting the same use cases are required. This
  - 1160 classification of interoperability tests is given by test scenarios. A test scenario thus selects a set of
  - 1161 use cases and is restricted to a sub-set of the full functionality of such a set;
- 1162 • Definition of test bed architecture.
  - 1163 - A test architecture is an abstract description of logical entities as well as their interfaces and
  - 1164 communication links involved in a test;
- 1165 • Identification of test bed interfaces, classified in the three following groups.
  - 1166 - Data: this group contains the interfaces where data is exchanged. Depending on the type of data
  - 1167 being exchanged, the interfaces are classified into three categories (Stimulating, Monitoring and
  - 1168 Tracing).
  - 1169 - Control: this group is used to configure and control the various entities in the test bed, and even the
  - 1170 EUTs, by passing necessary parameters.
  - 1171 - Test Operator: this group provides the capability of controlling the test bed control module. Through
  - 1172 this interface, a test operator would be able to select the test to be executed, to configure the different
  - 1173 entities involved in the tests and to analyze the results obtained during the test execution.
- 1174 • Development of interoperability test specifications.
  - 1175 - Developing Interoperable Function Statement (IFS) from base standards, if not already provided as
  - 1176 part of the base standard.
  - 1177 - Developing "Test Descriptions" (TDs) from base standards.

1178

## 1179 9.8 Further testing procedures

1180 Alongside the testing procedures promoted in the V-Model, further testing procedures exist which may fall  
1181 into one or more categories as described above.

- 1182 • Type and routine testing.
  - 1183 - A *type test* is made on one or more items representative of the production.
  - 1184 - A *routine test* is made on each individual item during or after manufacture.
- 1185 • Electrical testing.
  - 1186 - *Electrical testing* includes testing of electrical components, properties etc., e.g. the testing of electrical
  - 1187 insulation, immunity to earth fault or impedance.
- 1188 • Mechanical testing.
  - 1189 - *Mechanical testing* includes testing of mechanical components, properties etc., e.g. the testing of
  - 1190 resistance to heat and fire or protection against penetration of dust and water.
- 1191 • Certification testing.
  - 1192 - *Certification Testing includes* proving the behavior and conformance with a profile e.g. the grid code
  - 1193 requirements.

1194

## 1195 9.9 Experiences of creating BAIOPs for testing using the Interoperability process

1196 This section contains an experience and examples of creating BAIOPs using the process from use case to  
1197 Interoperability. Other experiences and examples are available in the annexes.

1198

1199  
1200  
1201  
1202  
1203  
1204  
1205  
1206  
1207  
1208  
1209  
1210  
1211  
1212  
1213  
1214  
1215

**9.9.1 Experiences of creating BAIOPs from the in EU FP7 project COTEVOS**

In annex12.5: Example and experiences of BAPs and BAIOPs in EU FP7 project COTEVOS, the first preliminary results using the interoperability method of this document are described. To assist interoperability of BAPs they can be extended to interoperability testing, the extended BAP is referred to as BAIOP. For interoperability testing in this case for Authentication, Roaming and Smart Charging the extensions are required on:

- Device configuration: e.g. EVs under test should have smart charging feature enabled.
- Test configuration: e.g. a Smart Grid with 2 EVs (EV1 and EV2) charging at an EVSE both at the same grid (e.g. LV feeder).
- BAP related test cases: e. g. a test case where, while EV1 is charging, the charge plan request of EV2 leads to a modified charge plan also for EV1, due to grid limits.
- Communication infrastructure (topology).

A possible BAIOP for the 2 use cases Authentication, Roaming and Smart Charging consists out of 7 BAPs (see section 8.9), which means we have selected and described what will be used from the following standards/specifications: ISO/IEC 15118, eMarket, Power Matcher, OCPP-alike, OCPP, RFID, and OCHP. See also the Figure 22 for all the information flows.

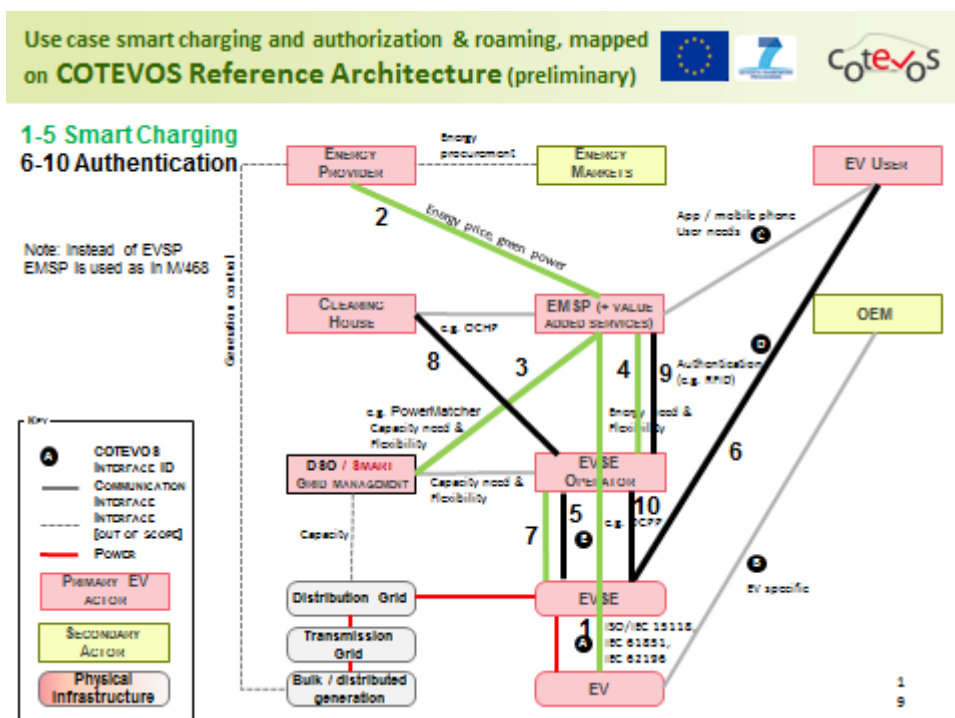

1216  
1217  
1218  
1219  
1220  
1221  
1222  
1223  
1224  
1225  
1226  
1227  
1228  
1229  
1230  
1231

**Figure 22 two eMobility use cases in COTEVOS Reference Architecture**

If the BAIOP with the test cases are executed by another party on a system with the same BAPs the results on system level should be the same. Of course data on the communication layer can be different (other ID of user/EVSE, other time stamps etc.), but on higher layer (information layer or above) it should lead to the same system results like: EV1 get assigned the requested charge plan, when EV2 is connected and the requested grid capacity is too low, as well the charge plan of EV2 and EV1 are renegotiated. If after that the available capacity is increased it should again lead to increased charging powers for at least one of the EVs. For more details on this example refer to annex 12.5: Example and experiences of BAPs and BAIOPs in EU FP7 project COTEVOS. The COTEVOS project is continuing till 2016.

**9.10 Testing for conformance**

The utility should request the manufacturer to demonstrate conformance against the specific profile. A utility should include in the contract (Statement of Work) that during the integration testing, the manufacturer should demonstrate conformance of its product towards the specific profile by means of a Conformance

1232  
1233  
1234  
1235

profile test. Devices that have successfully been conformance tested according the specific profile can be used for an interoperability test at location of the manufacturer as part of an (extended) Factory Acceptance Test (FAT). It is highly recommended to only use devices being successfully conformance tested according the specific profile in an interoperability test.

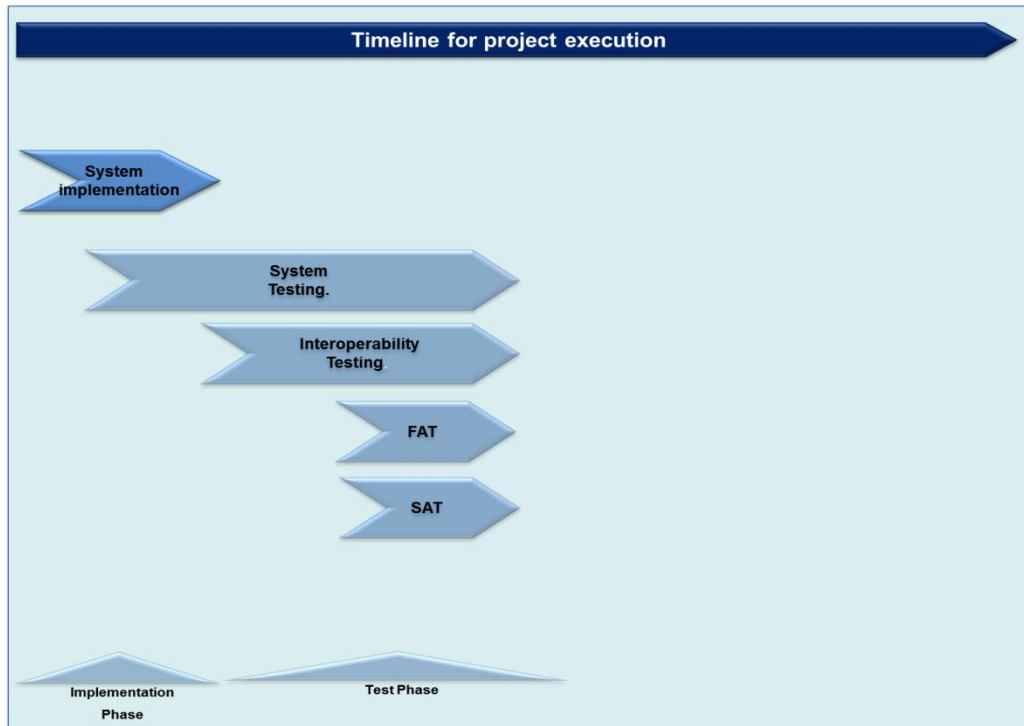

1236  
1237  
1238

**Figure 23 timeline for project execution**

1239  
1240  
1241  
1242  
1243

After a successful integration test, the system implementation can start. During the system test, an interoperability test on premises of the utility should be organized. The system test should take into account all parameters, configuration, setting etc. as it will be used in the real (field) environment. This interoperability test will demonstrate to the utility the success of achieving real interoperability of the system in the field.

## 1244 10. Development of the IOP tool

1245 Assessing existing testing procedures in identified Smart Grid standards resulted in the development of the  
1246 IOP Tool. The IOP Tool provides a filter of the relevant standards for Smart Grids including their existing  
1247 testing procedures to identify future interoperability requirements.

1248 The primary source was the final version of the set of standards by WG SS with other sources included to  
1249 provide further input for developing the interoperable methods.

1250 The classifications in alignment with the Smart Grid Architecture Model (SGAM) Framework were included.  
1251 Standards from ISO, IEC, ITU, CEN, CENELEC, ETSI as most relevant standardization bodies are listed  
1252 regarding the available testing requirements. The use of the IOP Tool is demonstrated as an example Use  
1253 Case in the annex 12.6.

1254

### 1255 10.1 Testing

1256 In the IOP Tool different types of testing are classified. A test can generally fall into more than one category.  
1257 Types of IOP testing in focus are generally introduced in the terms, but alongside IOP, further testing  
1258 requirements in standards do exist and may apply (see chapter 9.7 and 9.8 for details):

- 1259 • Electrical testing.
- 1260 • Mechanical testing.
- 1261 • System testing.
- 1262 • Acceptance testing.
- 1263 • Type and routine testing.

1264 EMC can be a considered part of electrical testing because EMC involves the way a product reacts on an  
1265 impact on its electrical and electronic design.

1266

### 1267 10.2 Structure of the IOP Tool

1268 This section introduces the structure of the IOP Tool which organizes the information as a set of rows, where  
1269 each row represents a specific standard and contains several columns of information.

1270

#### 1271 10.2.1 General information

1272 The IOP Tool contains the mapping of the standards to Systems according to the SGCG-SS. Three types of  
1273 systems are defined:

- 1274 • Domain specific systems, i.e. systems that can be mapped to a Domain (Generation, Transmission,  
1275 Distribution, DER, Customer Premises).
- 1276 • Function specific systems, that are usually crossing domain borders (Marketplace systems, Demand  
1277 flexibility systems, Smart metering systems, Weather observation and forecast systems).
- 1278 • Other systems usually focusing on administration features (asset management, clock reference,  
1279 communication management, device management, ...).

1280 The mapping of Smart Grids systems on the SGAM Smart Grid Plane is shown in Figure 24.

1281  
1282  
1283  
1284

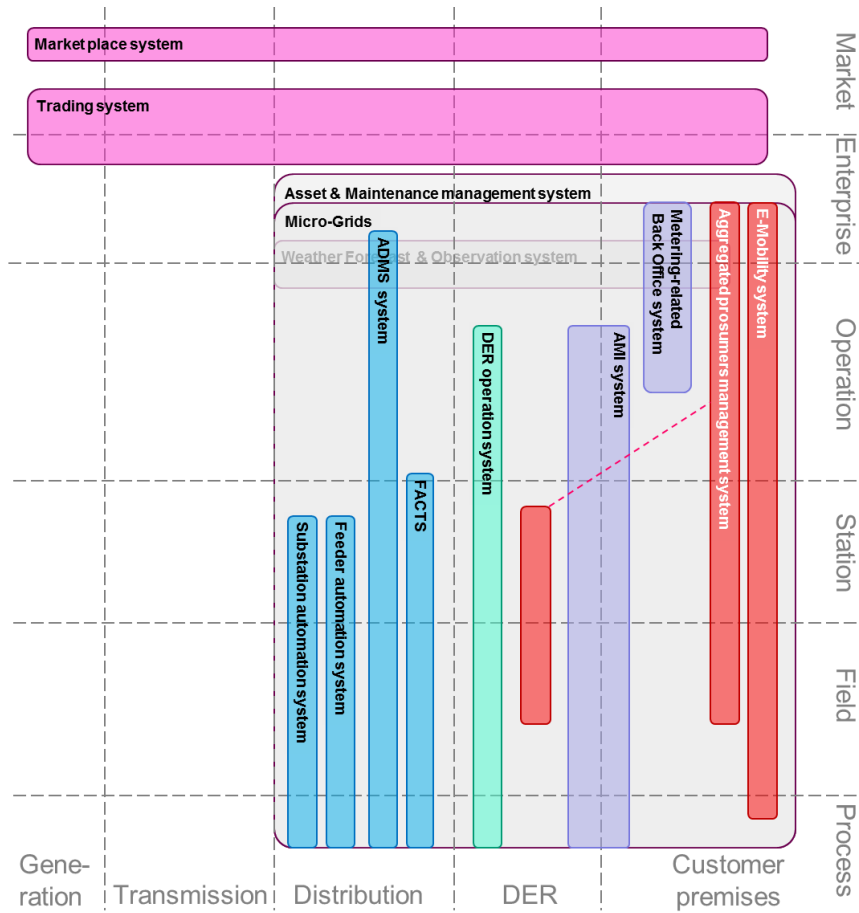

Figure 24 SGAM Smart Grid Plane

Figure 25 below shows an overview of the IOP tool.

1285  
1286  
1287

Standard	Title	Abstract	SGAM layers																Function specific and other systems														SGAM Zones			Testing		
			Crosscutting issues (WG SS)			Observation		Transmission		Distribution		DER		Customer premises		Market		Administration		Crosscutting		SGAM Zones			Testing													
			Components	Information	Interaction	General	Advanced	General	Advanced	General	Advanced	General	Advanced	General	Advanced	General	Advanced	General	Advanced	General	Advanced	General	Advanced	General	Advanced	General	Advanced	General	Advanced									
ETSI TS 101 991	Universal Mobile Telecommunications System (UMTS): Technical Specifications and Technical Reports for a UTRAN-based 3GPP system	ETSI TS 101 991 / 3GPP TS 25.101 Overview of Technical Specifications and Technical Reports for a UTRAN-based 3GPP system	x																																			
ETSI TS 101 992	Digital cellular telecommunications system (Phase 2): Technical Specifications and Technical Reports for a GPRS system	ETSI TS 101 992 / 3GPP TS 22.102 Overview of Technical Specifications and Technical Reports for a GPRS system	x																																			
ETSI TS 101 993	Open Data Communication in Building Automation, Controls and Building Management - Home and Building Electronics Systems	Part 1: Protocol and system requirement, Part 2: KNXnet/IP Communication	x																																			
EN 15221-2	Open Data Communication in Building Automation, Controls and Building Electronics Systems - Part 2: HomeNet Communication	As for Home and Building Electronics Systems (HBE) this specifies European Standard specifies for the details of Building Automation and Control System Application and Building Management (BACS) common data for a class of multi-application bus systems where the functions are described and linked through a common communication protocol. This European Standard sets the basic requirements to products and systems.	x																																			
EN 15221-1	Open Data Communication in Building Automation, Controls and Building Electronics Systems - Part 1: Data exchange	This European Standard covers a data exchange protocol for the remote reading of all kinds of meters (water, gas, heat) on the basis of the open communication layer but not the device layer and the programmer. Above protocol.	x																																			
EN 15221-3	Communication systems for and remote reading of meters - Part 3: Dedicated application layer	The European Standard specifies parameters for the application layer for baseband communication over twisted pair (MBBus).	x																																			
EN 15221-4	Communication systems for and remote reading of meters (Radio meter reading) for operation in (RF) networks	This European Standard specifies the requirements of parameters for the physical and the link layer for systems using radio to read remote meters. The primary focus is to type the Short Range Device (SRD) substandard category.	x																																			
EN 15221-5	Communication systems for and remote reading of meters (Radio meter reading) for operation in (RF) networks	This standard defines the requirements for the protocols to use when performing Hgig in wireless meter reader networks. This document is an extension to Part 4 of EN 15221 Wireless meter reader	x																																			
EN 14908	Open Data Communication in Building Automation, Controls and Building Management - Building Network Protocol - Part 1: Protocol Stack	Series of standards for open data transmission in building automation, control and building management systems. This specification applies to a communication protocol for networked control systems. The protocol provides peer-to-peer communication for networked control and is suitable for implementing both peer-to-peer and master-slave control schemes. This specification describes services in	x																																			
EN 14908-2	Open Data Communication in Building Automation, Controls and Building Management - Building Network Protocol - Part 2: Tested	This European Standard specifies the control network protocol (CNP) layer topology, meter, gas, channel and services as a companion document to CNP. Part 1. The document supports communication at 70,5 kbps between multiple nodes, each of which consists of at least one protocol processor, an application processor, a power	x																																			

Figure 25 Snapshot of IOP Tool

1288  
1289

Columns A to C of the IOP tool contain general information on the listed standards according to the WG SS final list of standards.

1290

Column D: Abstract, based on various sources, in most cases extract from the respective standard.

1291

Column BP: Comments from WG Interoperability.

1292

1293 **10.2.2 Sources**

1294 The IOP Tool contains data of more than 500 standards which are identified as relevant for the Smart Grid  
1295 according to the WG SS final list of standards.

1296

1297 **10.2.3 Layers and crosscutting issues**

1298 Columns **E** to **N** contain the assignment of the listed standards to the SGAM layers and to crosscutting  
1299 issues according to FSS report [SG-CG/G]. Figure 26.

1300

1301

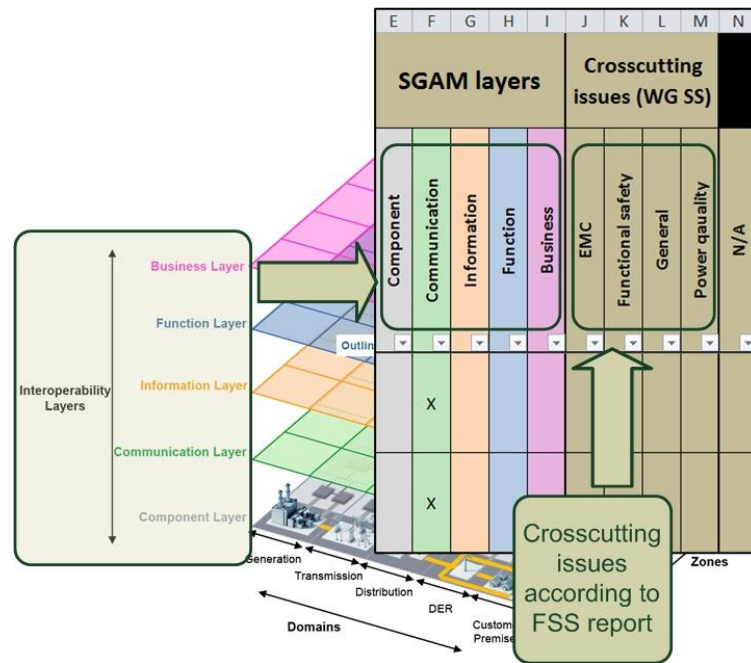

Figure 26 IOP Tool - SGAM layers and crosscutting issues

1302

1303

1304

1305 **10.2.4 Systems**

1306 Columns **O** to **AZ** contain the assignment of the listed standards to the systems according to FSS report  
1307 [SG-CG/H]. The IOP Tool divides SGAM domain specific systems (Figure 27) and function specific and other  
1308 systems (Figure 28).

1309



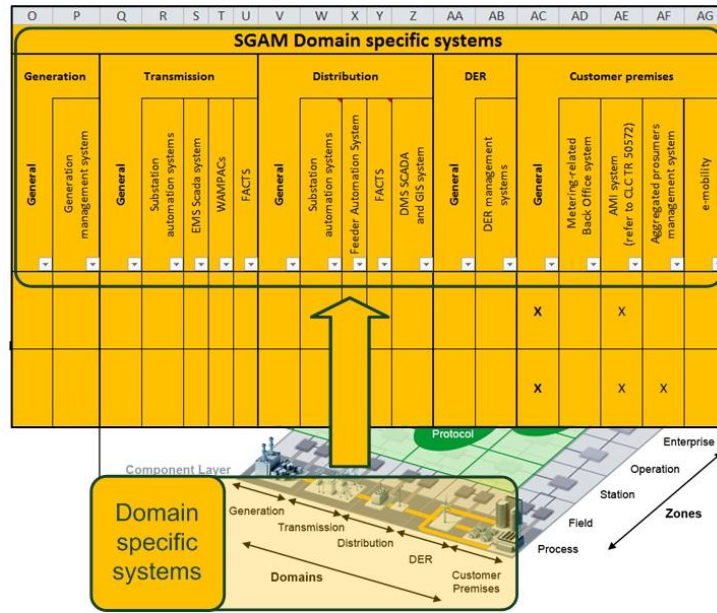

1310  
1311  
1312

Figure 27 IOP Tool – Domain specific systems

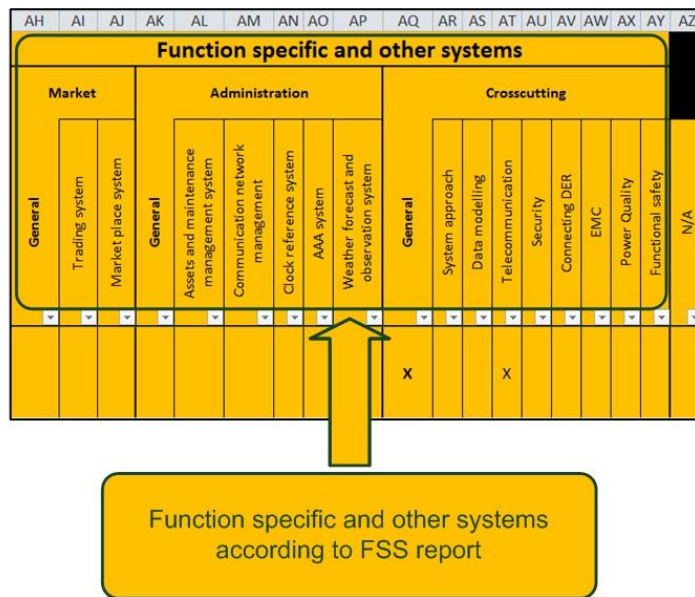

1313  
1314  
1315  
1316  
1317  
1318

Figure 28 IOP Tool - Function specific and other systems

10.2.5 Zones

Columns **BA** to **BG** contain the assignment of the listed standards to the zones according to FSS report [SG-CG/H] Figure 29.

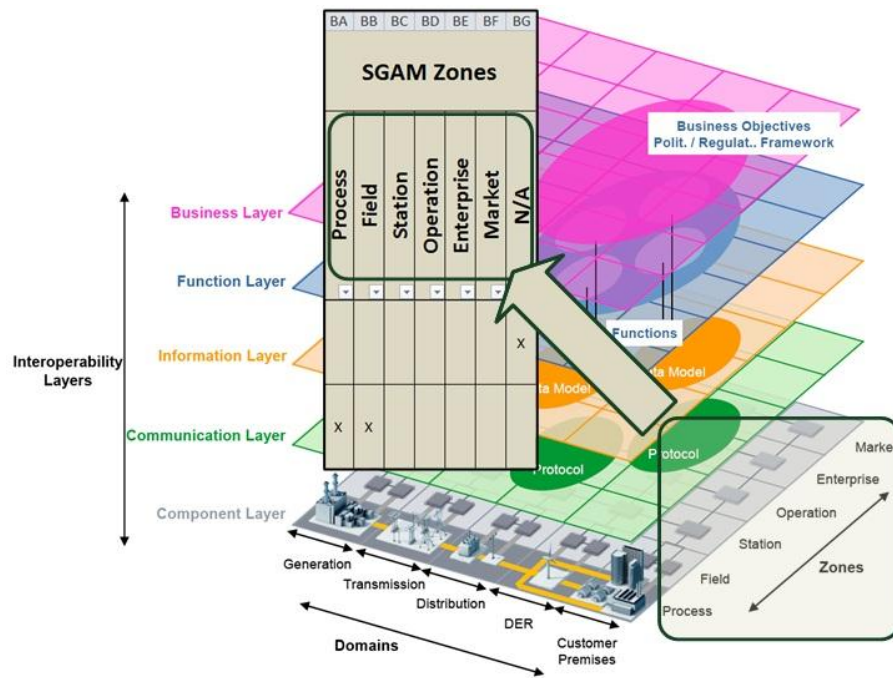

Figure 29 IOP Tool – Zones

1319

1320

1321

1322

### 10.2.6 Testing

1323

The testing according to section 10.1 is classified in columns **BH** to **BO** of the IOP Tool.

1324

1325

### 10.3 Prioritization of Systems

1326

The prioritization of systems strongly depends on a corresponding use case and which standards are required to fulfill this use case. In Annex 12.6 the use of the IOP Tool is demonstrated as an example to identify the required standards for prioritized systems. The use case “Control reactive power of DER unit” is considered as one of the functionalities that have high priority in order to implement the SG.

1327

1328

1329

1330

### 10.4 Survey on existing IOP procedures

1331

As aforementioned, the prioritization of systems and standards for IOP purposes depends on the individual requirements of use cases broken down to layer level and can be supported by the application of the IOP tool. The following subsections detail the outcome of the general survey on currently existing IOP standards as well as standardized testing procedures established by international standardization committees and associated User Groups.

1332

1333

1334

1335

1336

1337

#### 10.4.1 Existing IOP Standards

1338

The following existing standards have been identified as relevant in the context of IOP testing. They already contain specific provisions for conformance and/or interoperability testing and therefore have also been classified according to specific systems.

1339

1340

Standard	Title	Abstract	System
EN 50065-1	Signaling on low-voltage electrical installations in the frequency range 3 kHz to 148,5 kHz - Part 1: General requirements, frequency bands and electromagnetic disturbances	This standard deals with electrical equipment using frequencies in the range of 3 kHz to 148,5 kHz to transmit information on low voltage electrical installations, either on the public supply system or within buildings. Frequency bands, limits for the output, limits for conducted and radiated interference and methods of measurement are defined.	Customer Premises
EN 55011	Industrial, scientific and medical equipment - Radio-frequency disturbance characteristics - Limits and methods of measurement	This standard applies to the radio disturbance suppression of industrial, scientific, medical and domestic (radio-frequency) equipment and ISM rf applications in the frequency range from 150 kHz to 400 GHz.	Crosscutting
EN 55022	Information technology equipment - Radio disturbance characteristics - Limits and methods of measurement	This standard deals with the limitation of the radio-frequency emission (radio disturbance suppression) of information technology equipment (ITE) and specifies the relevant limits and measuring methods.	Crosscutting
EN 55024	Information technology equipment - Immunity characteristics - Limits and methods of measurement	This standard specifies requirements and associated test methods for the immunity of information technology equipment (ITE). Particular test conditions and performance criteria for particular kind of equipment are contained in the normative annexes.	Crosscutting
EN 55032	Electromagnetic compatibility of multimedia equipment - Emission requirements	This publication applies to multimedia equipment (MME), intended primarily for professional use and having a rated rms supply voltage not exceeding 600 V. Objectives are to establish requirements which will provide an adequate level of protection of the radio spectrum allowing radio services to operate as intended in the frequency range 9 kHz to 400 GHz and to specify procedures to ensure reproducibility of measurement and the repeatability of results.	Crosscutting
EN 61400-25	Wind turbines - Part 25: Communications for monitoring and control of wind power plants	The focus of the IEC 61400-25 series is on the communications between wind power plant components such as wind turbines and actors such as SCADA Systems. Internal communication within wind power plant components is beyond the scope of the IEC 61400-25 series.	Transmission, Distribution, Administration, Crosscutting
EN 61850-10	Communication networks and systems in substations - Part 10: Conformance testing	This part of IEC 61850 defines the methods and abstract test cases for conformance testing of devices used in substation automation systems, and the metrics to be measured within devices according to the requirements defined in IEC 61850-5.	N/A
EN 61850-4	Communication networks and systems for power utility automation - Part 4: System and project management	Applies to projects associated with process near automation systems of power utilities (AUS, utility automation system), like e. g. substation automation systems (SAS).	N/A
EN 61850-5	Communication networks and systems for power utility automation - Part 5: Communication requirements for functions and device models	Communication networks and systems for power utility automation	N/A

Standard	Title	Abstract	System
EN 61850-6	Communication networks and systems for power utility automation - Part 6: Configuration description language for communication in electrical substations related to IEDs	Specifies a file format for describing communication related IED (Intelligent Electronic Device) configurations and IED parameters, communication system configurations, switchyard (function) structures, and the relations between them.	Generation, Transmission, Distribution, DER
EN 61850-7-1	Communication networks and systems for power utility automation - Part 7-1: Basic communication structure - Principles and models	Introduces the modeling methods, communication principles, and information models that are used in the various parts of the IEC 61850-7-x series.	Crosscutting
EN 61869	Instrument transformers	Part 1: General requirements, Part 2: Current Transformers, Part 3: Additional requirements for inductive voltage transformers, Part 4: Combined Transformers, Part 5: Additional requirements for capacitor voltage transformers, Part 6: Additional general requirements for Low Power Instrument Transformers, Part 9: Digital interface for instrument transformers	Transmission, Distribution
EN 61970 (all parts)	Energy management system application program interface (EMS-API)	This standard provides a set of guidelines and general infrastructure capabilities required for the application of the EMS-API interface standards. In order to provide a framework for their application, a reference model is defined being based on a component architecture that places the focus of the standards on component interfaces for information exchange between applications to be integrated within a control center as well as within its environment (including information exchange e. g. with other control centers, and distribution systems).	Transmission, Distribution, DER, Market, Administration
EN 62056 (all parts)	Electricity metering data exchange - The DLMS/COSEM suite	IEC62056 standards are the International Standard versions of the DLMS (Device Language Message Specification) / COSEM (Companion Specification for Energy Metering) specification.	Customer Premises, Crosscutting
EN 62439	Industrial communication networks - High availability automation networks	General concepts and calculation methods, Media Redundancy Protocol (MRP), Parallel Redundancy Protocol (PRP) and High availability Seamless Redundancy (HSR), Cross-network Redundancy Protocol (CRP), Beacon Redundancy Protocol (BRP), Distributed Redundancy Protocol (DRP), Ring-based Redundancy Protocol (RRP)	Generation, Distribution,
prEN 55035	Electromagnetic Compatibility of Multimedia equipment - Immunity Requirements	This standard deals with the immunity of multimedia equipment and specifies the relevant test levels and measuring methods and the general and function dependent specific performance criteria.	Crosscutting
ETSI TS 102 237-1	Telecommunications and Internet Protocol - Harmonization Over Networks (TIPHON) Release 4; Interoperability test methods and approaches; Part 1: Generic approach to interoperability testing	The present document gives general guidance on the specification and execution of interoperability tests for communication systems in Next Generation Networks (NGN). It provides a framework within which interoperability test specifications for a wide range of product types can be developed.	N/A

Standard	Title	Abstract	System
ETSI EG 202 387	Telecommunications and Internet converged Services and Protocols for Advanced Networking (TISPAN); Security Design Guide; Method for application of Common Criteria to ETSI deliverables	The purpose of the document is to provide developers of security standards with a summary of the requirements of ISO/IEC-15408 in the context of standardization and to give guidance on how formal methods and other engineering techniques can be used to ensure that standards meet, as far as is possible, the requirements of ISO/IEC 15408 and do not prevent an implementation from achieving an appropriate EAL.	Crosscutting
ETSI EG 202 549	Telecommunications and Internet converged Services and Protocols for Advanced Networking (TISPAN) - Design Guide - Application of security countermeasures to service capabilities	This work item is intended to give guidance on the application of countermeasures defined in TS 102 165-2 (editions 1 and 2) to make individual service capabilities secure both atomically and in combination.	Crosscutting
ETSI ES 202 382	Telecommunications and Internet converged Services and Protocols for Advanced Networking (TISPAN) - Security Design Guide - Method and proforma for defining Protection Profiles	To specify the method and a proforma for definition of Protection Profiles in ETSI standards. This is derived in part from the work defined in 33wgTD054 and is directly related to the actual protection profile to be developed by the STF identified in 33wgTD042.	Crosscutting
ETSI ES 202 383	Telecommunications and Internet converged Services and Protocols for Advanced Networking (TISPAN) - Security Design Guide - Method and proforma for defining Security Targets	To define both the method and proforma for security targets as defined in the Common Criteria. This to be the 3rd part of a 3-part document as outlined in 33wgTD054.	Crosscutting
ETSI EG 202 798	Intelligent Transport Systems (ITS); Testing; Framework for conformance and interoperability testing	The scope of the present document is to support ITS projects on the development of test specifications for ITS base standards from ETSI, ISO, CEN and other Standard Developing Organizations by providing an ITS testing framework for conformance testing and an ITS testing framework for interoperability testing.	N/A
ETSI TR 102 437	Electronic Signatures and Infrastructures (ESI) - Guidance on TS 101456 (Policy Requirements for certification authorities issuing qualified certificates)	This document provides guidance on the requirements in ETSI TS 101456 V1.2.1 (2002-04) - Policy requirements for certification authorities issuing qualified certificates. This guidance is intended for use by independent bodies and their assessors, certification service providers and other interested parties	Crosscutting
ETSI TS 101 456	Electronic Signatures and Infrastructures (ESI) - Policy requirements for certification authorities issuing qualified certificates	The present document specifies baseline policy requirements on the operation and management practices of certification authorities issuing qualified certificates in accordance with the Directive 1999/93/EC of the European Parliament and of the Council on a Community framework for electronic signatures.	Crosscutting
ETSI TS 102 042	Electronic Signatures and Infrastructures (ESI) - Policy requirements for certification authorities issuing public key certificates	This work item is to make minor updates to TS 102042 to align with the new CAB Forum Extended Validation Guidelines	Crosscutting



Standard	Title	Abstract	System
IEC 60870-5-6	Telecontrol equipment and systems - Part 5-6: Guidelines for conformance testing for the IEC 60870-5 companion standards	This standard specifies methods for conformance and possible interoperability testing of telecontrol equipment such as substation automation systems (SAS) and telecontrol systems, including front-end functions of SCADA.	N/A
IEC 61131	Programmable controllers	Series of standards on programmable controllers and their associated peripherals	Generation, DER
IEC 61334 (all parts)	Distribution automation using distribution line carrier systems	Distribution automation using distribution line carrier systems	Customer Premises
IEC 61499	Function blocks	Part 1: Architecture, Part 2: Software tool requirements, Part 4: Rules for compliance profiles	Generation, DER
IEC 62052-31	Electricity metering equipment (AC) - General requirements, tests and test conditions - Part 31: Safety requirements	Safety requirements	N/A
IEC 62056	Electricity metering - Data exchange for meter reading, tariff and load control / The DLMS/COSEM suite	IEC 62056 standards are the International Standard versions of the DLMS (Device Language Message Specification) / COSEM (Companion Specification for Energy Metering) specification.	Customer Premises, Crosscutting
IEC 62264	Enterprise system integration	IEC 62264 is a multi-part standard that defines the interfaces between enterprise activities and control activities.	Generation
IEC 62271-3	High-voltage switchgear and control gear - Part 3: Digital interfaces based on IEC 61850	This Standard is applicable to high-voltage switchgear and control gear and assemblies thereof and specifies equipment for digital communication with other parts of the substation and its impact on testing. This Standard is a product standard based on the IEC 61850 series.	Transmission, Distribution
IEC 62351-4	Power systems management and associated information exchange - Data and communication security - Part 4: Profiles including MMS	This part of IEC 62351 specifies procedures, protocol extensions, and algorithms to facilitate securing ISO 9506 – Manufacturing Message Specification (MMS) based applications.	Administration, Crosscutting
IEC TS 60870-5-601	Telecontrol equipment and systems - Part 5-601: Conformance test cases for the IEC 60870-5-101 companion standard	The document describes test cases for conformance testing of telecontrol equipment, Substation Automation Systems (SAS) and telecontrol systems, including front-end functions of SCADA.	N/A
IEC TS 60870-5-604	Telecontrol equipment and systems - Part 5-604: Conformance test cases for the IEC 60870-5-104 companion standard	The document describes test cases for conformance testing of telecontrol equipment, Substation Automation Systems (SAS) and telecontrol systems, including front-end functions of SCADA.	N/A
IEC/ISO 15118	Road Vehicles - Vehicle to grid communication interface	Part 1: General information and use-case definition, Part 2: Technical protocol description and Open Systems Interconnections (OSI) layer requirements, Part 3: Physical layer and Data Link layer requirements	Crosscutting
ISO/IEC 15408	Information technology - Security techniques - Evaluation criteria for IT security	Part 1: Introduction and general model, Part 2: Security functional components, Part 3: Security assurance components	N/A



Standard	Title	Abstract	System
ITU-T G.9901	Narrowband orthogonal frequency division multiplexing power line communication transceivers - Power spectral density specification	<p>This Recommendation specifies the control parameters that determine spectral content, power spectral density (PSD) mask requirements, a set of tools to support the reduction of the transmit PSD, the means to measure this PSD for the transmission over power line wiring, as well as the allowable total transmit power into a specified termination impedance. It complements the system architecture, physical layer (PHY), and data link layer (DLL) specifications in Recommendations ITU T G.9902 (G.hnem), ITU-T G.9903 (G3-PLC) and ITU-T G.9904 (PRIME).</p>	Transmission, Distribution, Customer Premises, Crosscutting
ITU-T G.9902	Narrowband orthogonal frequency division multiplexing power line communication transceivers for ITU-T G.hnem networks	<p>Recommendation ITU-T G.9902 contains the physical layer (PHY) and the data link layer (DLL) specifications for the ITU-T G.9902 narrowband orthogonal frequency division multiplexing (OFDM) power line communication transceivers operating over alternating current and direct current electric power lines over frequencies below 500 kHz. This Recommendation supports indoor and outdoor communications over low voltage-lines, medium-voltage lines, through transformer low-voltage to medium-voltage and through transformer medium-voltage to low-voltage power lines in both urban and long-distance rural communications. This Recommendation addresses grid to utility meter applications, advanced metering infrastructure (AMI) and other 'Smart Grid' applications such as the charging of electric vehicles, home automation and home area network (HAN) communications scenarios.</p> <p>This Recommendation does not contain the control parameters that determine spectral content, power spectral density (PSD) mask requirements and the set of tools to support a reduction of the transmit PSD; all of which are detailed in [ITU-T G.9901].</p>	Transmission, Distribution, Customer Premises, Crosscutting
ITU-T G.9903	Narrowband orthogonal frequency division multiplexing power line communication transceivers for G3-PLC networks	<p>Recommendation ITU T G.9903 contains the physical layer (PHY) and data link layer (DLL) specification for the G3-PLC narrowband orthogonal frequency division multiplexing (OFDM) power line communication transceivers for communications via alternating current and direct current electric power lines over frequencies below 500 kHz. This Recommendation supports indoor and outdoor communications over low-voltage lines, medium-voltage lines, through transformer low-voltage to medium-voltage and through transformer medium-voltage to low-voltage power lines in both urban and long distance rural communications. This Recommendation addresses grid to utility meter applications, advanced metering infrastructure (AMI), and other 'Smart Grid' applications such as the charging of electric vehicles, home automation and home area networking (HAN) communications scenarios.</p> <p>This Recommendation does not contain the control parameters that determine spectral content, power spectral density (PSD) mask requirements and the set of tools to support a reduction of the transmit PSD; all of which are detailed in Recommendation ITU-T G.9901.</p>	Transmission, Distribution, Customer Premises, Crosscutting

Standard	Title	Abstract	System
ITU-T G.9904	Narrowband orthogonal frequency division multiplexing power line communication transceivers for PRIME networks	<p>This Recommendation contains the physical layer (PHY) and data link layer (DLL) specification for PRIME narrowband orthogonal frequency division multiplexing (OFDM) power line communication transceivers for communications via alternating current and direct current electric power lines over frequencies below 500 kHz. This Recommendation supports indoor and outdoor communications over low-voltage lines, medium-voltage lines, through transformer low-voltage to medium-voltage and through transformer medium-voltage to low-voltage power lines in both urban and in long distance rural communications. This Recommendation addresses grid to utility meter applications, advanced metering infrastructure (AMI), and other 'Smart Grid' applications such as the charging of electric vehicles, home automation and home area networking (HAN) communications scenarios.</p> <p>This Recommendation removes the control parameters that determine spectral content, power spectral density (PSD) mask requirements, and the set of tools to support reduction of the transmit PSD, all of which have been moved to [ITU-T G.9901].</p>	Transmission, Distribution, Customer Premises, Crosscutting
ITU-T G.9905	Centralized metric-based source routing	<p>Recommendation ITU-T G.9905 specifies centralized metric based source routing (CMSR), a proactive, layer 2 multi-hop routing protocol. CMSR is a proactive routing protocol which can find and maintain reliable routes considering the link quality of both directions. The routing control packet overhead of CMSR is quite low compared to existing proactive routing protocols such as optimized link state routing (OLSR), so that it can be applied for large-scale networks even on narrow band power line communication (PLC) networks.</p>	Customer Premises, Crosscutting
ITU-T G.9959	Short range narrow-band digital radio communication transceivers - PHY and MAC layer specifications	<p>This Recommendation contains the MAC/PHY layer specification for short range narrow-band digital radio communication transceivers. This Recommendation is a joint work of ITU-R and ITU T, each contributing material from their respective remits. This Recommendation contains the non-radio (frequency) related aspects of the radio communication transceiver. The Recommendation specifies sub 1 GHz transceivers which shall be interoperable with transceivers complying with Annex A of this Recommendation.</p>	Transmission, Distribution, Customer Premises, Crosscutting
ITU-T G.991.2	Single-pair high-speed digital subscriber line (SHDSL) transceivers	<p>This Recommendation describes a transmission method for data transport in telecommunications access networks.</p>	Crosscutting
ITU-T G.992.1	Asymmetric digital subscriber line (ADSL) transceivers	<p>This Recommendation describes Asymmetric Digital Subscriber Line (ADSL) Transceivers on a metallic twisted pair that allows high-speed data transmission between the network operator end (ATU-C) and the customer end (ATU-R).</p>	Crosscutting
ITU-T G.992.3	Asymmetric digital subscriber line transceivers 2 (ADSL2)	<p>This Recommendation defines a variety of frame bearers in conjunction with one of two other services, or without underlying service, dependent on the environment. It specifies the physical layer characteristics of the asymmetric digital subscriber line (ADSL) interface to metallic loops.</p>	Crosscutting

Standard	Title	Abstract	System
ITU-T G.993.1	Very high speed digital subscriber line transceivers (VDSL)	G.993.1 VDSL (Very high speed Digital Subscriber Line) permits the transmission of asymmetric and symmetric aggregate data rates up to tens of Mbit/s on twisted pairs. G.993.1 includes worldwide frequency plans that allow asymmetric and symmetric services in the same group of twisted pairs.	Crosscutting
ITU-T G.996.1	Test procedures for digital subscriber line (DSL) transceivers	This Recommendation describes the testing procedures for ITU-T Digital Subscriber Line (DSL) Recommendations.	Crosscutting
ITU-T G.998.3	Multi-pair bonding using time-division inverse multiplexing	This Recommendation describes a method for bonding of multiple digital subscriber lines (DSL) using Time-Division Inverse Multiplexing (TDIM). It provides a specification of the TDIM protocol in sufficient detail, to allow development and testing of interoperable implementations for both transmitter and receiver.	Crosscutting

**Table 1 selected standards**

#### 10.4.2 Key examples of existing standardized testing procedures to provide IOP

##### 10.4.2.1 IEC 61850

The IEC/EN 61850 series define general requirements, mainly regarding construction, design and environmental conditions for utility communication and automation IEDs and systems in power plant and substation environments. These general requirements are in line with requirements for IEDs used in similar environments, for example measuring relays and protection equipment.

Part 5 standardizes the communication between intelligent electronic devices (IEDs) and defines the related system requirements to be supported. The goal of this standard is to provide interoperability between the IEDs from different suppliers or, more precisely, between functions to be performed in the power system but residing in the IEDs from different suppliers. Interchangeability is outside the scope of this standard, but the objective of interchangeability in this area will be supported by following this standard.

Interoperability depends both on device properties and system design and engineering. Compliance tests shall be performed to verify that the communication behavior of a device as system component is compliant with the interoperability definition of this standard. Since the goal of the standard is interoperability, compliance with the standard means that interoperability is proven. The conformance test specification shall describe what tests have to be applied to a device checking that the communication function is correctly performed with a complementary device or, generally, with the rest of the system.

Also the pass criteria have to be well defined. Since it is not possible to test any device against any other device on the market conformance tests may involve the use of various simulators to represent the context of the system and of the communication network.

If it is not possible to test an IED in a reasonable test system for interoperability then a limited performance test shall prove conformance of the data model according to the implemented functions with IEC 61850-5 and of the implemented services according to the communication behavior needed by implemented functions according to IEC 61850-5. This will reduce the risk of not matching interoperability in the system.

The engineering process as such is outside the scope of the standard. Nevertheless, building interoperable systems requires standardized configuration files which may be exchanged between engineering tools. Therefore, they have to fulfill some minimum requirements regarding the exchange of these files. Definitions of the configurations files and minimum tool requirements are found in IEC 61850-6.

Part 10 specifies standard techniques for testing of conformance of client, server and sampled value devices and engineering tools, as well as specific measurement techniques to be applied when declaring performance parameters. The use of these techniques will enhance the ability of the system integrator to integrate IEDs easily, operate IEDs correctly, and support the applications as intended.

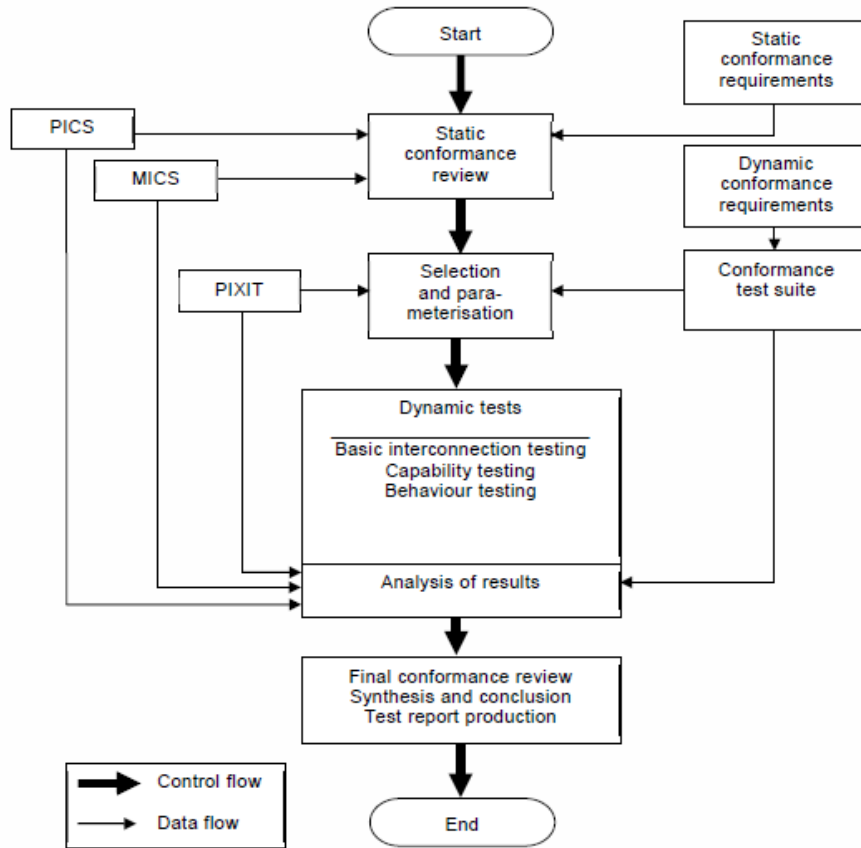

Figure 30 Conceptual conformance assessment process according to IEC 61850-10

#### 10.4.2.2 IEC 60870-5

The IEC/EN 60870-5 series applies to telecontrol equipment and systems for monitoring and controlling geographically widespread processes.

For the time being three companion standards out of this series exist:

- IEC 60870-5-101 applies to telecontrol equipment and systems with coded bit serial data transmission.
- IEC 60870-5-103 applies to protection equipment with coded bit serial data transmission for exchanging information with components of a control system in a substation.

The successor of these companion standards is IEC 61850.

- IEC 60870-5-104 presents a combination of the application layer of IEC 60870-5-101 and the transport functions provided by TCP/IP (Transmission Control Protocol/Internet Protocol).

They define telecontrol companion standards that enable interoperability among compatible telecontrol equipment. The specifications present a functional profile for basic telecontrol tasks.

Although these companion standards define the most important user functions, other than the actual communication functions, this cannot guarantee complete compatibility and interoperability between equipment of different vendors. An additional mutual agreement is normally required between concerned parties regarding the methods to use for defining communication functions, taking into account the operation of the entire telecontrol equipment.

Companion standards specified are compatible with base standards defined in IEC 60870-5-1 to IEC 60870-5-5.

Part 5-6 specifies methods for conformance testing of telecontrol equipment, amongst Substation automation systems (SAS) and telecontrol systems, including Front-End functions of SCADA.

Part 5-6 facilitates interoperability by providing a standard method of testing protocol implementations, but it does not guarantee interoperability of devices. It is expected that using this standard during testing will minimize the risk of non-interoperability.

1403 The goal of Part 5-6 is to enable unambiguous and standardized evaluation of IEC 60870-5 companion  
1404 standard protocol implementations. The guidelines and conditions for the testing environment are described.  
1405 It is mainly dealing with communication conformance testing; therefore other requirements, like e.g. safety or  
1406 EMC are not covered.

1407 The detailed test cases per companion standard, containing among others mandatory and optional  
1408 mandatory test cases are published as Technical Specifications:

- 1409 • IEC TS 60870-5-601 for the telecontrol companion standard IEC 60870-5-101.
- 1410 • IEC TS 60870-5-604 for the telecontrol companion standard IEC 60870-5-104.

1411 IEC TS 60870-5-101 and IEC TS 60870-5-104 describe test cases for conformance testing of telecontrol  
1412 equipment, Substation Automation Systems (SAS) and telecontrol systems, including front-end functions of  
1413 SCADA.

1414

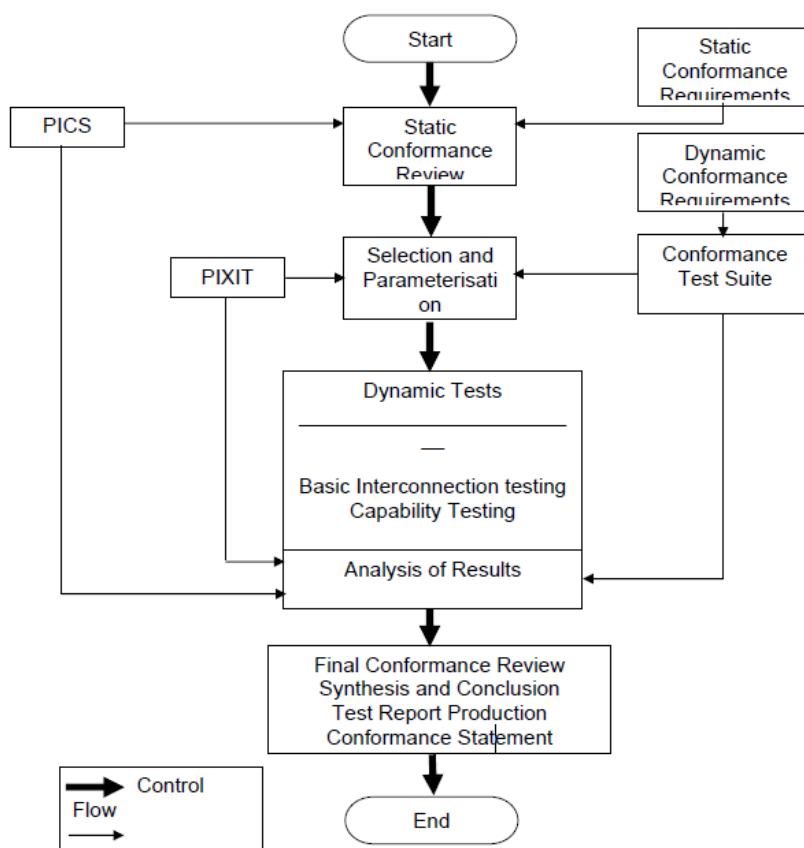

1415

1416

**Figure 31 Conceptual conformance assessment process according to IEC 60870-5-6**



Table 24 – Command transmission function Conformance Test Procedures

These procedures are passed only if the mandatory procedures and test cases are passed for each supported ASDU described in the PICS. The detailed result should be reported as in 5.6.

Test No.	Test	Description	Reference	Required
5.4.24.1	Command transmission – sequential procedure: Select and Execute	The Controlling station sends a Single, Double, Regulating step or Setpoint Command message (look at PICS for the supported ASDUs) with COT = 6, C_SC/DC/SE/RC_ACT, and S/E=1 (SELECT) to the Controlled station	IEC 60870-5-101, 7.4.7 IEC 60870-5-5, 6.8.1	PICS, 8.6
		The Controlled station mirrors the same ASDU with COT=7, C_SC/DC/SE/RC_ACTCON, to the Controlling station	IEC 60870-5-101, 7.4.7 IEC 60870-5-5, 6.8.1	PICS, 8.6
		The Controlling station sends the same Command message with COT=6, C_SC/DC/SE/RC_ACT, and S/E=0 (EXECUTE) to the Controlled station	IEC 60870-5-101, 7.4.7 IEC 60870-5-5, 6.8.1	PICS, 8.6
		The Controlled station mirrors the same ASDU with COT=7, C_SC/DC/SE/RC_ACTCON, to the Controlling station	IEC 60870-5-101, 7.4.7 IEC 60870-5-5, 6.8.1	PICS, 8.6
		The Controlled station generates an event (RETURN_INF) with COT=11(RETURN_INF caused by a remote command) or COT=12 (RETURN_INF caused by a local command), when the status of the (Process) Information Object that is associated with the command object changes as a result of the command.	IEC 60870-5-101, 7.4.7 IEC 60870-5-101, 7.4.7 IEC 60870-5-5, 6.8.1	PICS, 8.6
		The controlled station may send the RETURN_INF with COT=3, 11, or 12 after the ACTTERM. The Controlling station performs an overall check on the correct command procedure and corresponding status change, regardless of the order in which they occur.	IEC 60870-5-101, 7.4.7 IEC 60870-5-5, 6.8.1	PICS, 8.6
		The Controlled station mirrors the previous Command message with COT=10, C_SC/DC/SE/RC_ACTTERM (for SE if supported as in the PICS), to the Controlling station	IEC 60870-5-101, 7.4.7 IEC 60870-5-5, 6.8.1	PICS, 8.6
		Command function during a running general interrogation is processed and executed without waiting for the GI to finish	IEC 60870-5-5, Clause 5	PICS, 8.6
		Command function EXECUTE after SELECT should be received within the configured delay in the controlled station.	IEC 60870-5-5, 6.8.1	PICS, 8.6
		Command execution in progress should be completed with status change and ACTTERM (for SE if supported as in the PICS) within the configured delay in the controlling station. The controlled station may send the RETURN_INF with COT=3, 11, or 12 after the ACTTERM if and only if the Controlling station performs an overall check on the correct command procedure and corresponding status change, regardless of the order in which they occur.		PICS, 8.6
The values of the object(s) transferred and stored on the controlling station should represent the actual values on the controlled station		PICS, 8.6		

Figure 32 Example of test cases out of IEC TS 60870-5-601

**Explanation:**

Figure 32 shows an example of a test case in IEC 60870-5-601.

Test case numbering syntax is Sub clause number + Table number + test case number.

Test cases are Mandatory depending on the description in the column 'Required'. The following situations are possible:

- M = Mandatory test case regardless if enabled in the PICS/PIXIT, not only in one situation but during execution of all the tests as in the PICS and/or PIXIT.
- PICS, x.x = Mandatory test case if the functionality is enabled in the PICS (by marking the applicable check box), with a reference to the Sub clause number of the PICS (x.x); For example: PICS 8.x always refers to 60870-5-101:2003, Clause 8.
- PIXIT = Mandatory test case if the functionality is enabled/described in the PIXIT. Verification of these test cases by the user/owner of the PIXIT is required before the test is started.

For each test case, the test results need to be marked in the appropriate column of the test result. Each test case can either pass the test (Passed), fail the test (Failed), be not applicable when the configuration value is not supported by the device (N.A.), or the test case was not performed (Empty). Ideally there should be no empty boxes when testing is complete.

The final step to interoperability, with regard to conformance testing, is the verification of the interoperability of the DUT with other devices. Interoperability testing is outside the scope of this standard but recommendable when the DUT will be used in a system before go into operation.

**10.4.2.3 IEC 61400-25**

The IEC 61400-25 standard defines the information and information exchange in a way that is independent of a concrete implementation (i.e., it uses abstract models). The standard also uses the concept of virtualization. Virtualization provides a view of those aspects of a real device that are of interest for the information exchange with other devices. Only those details that are required to provide interoperability of devices are defined in IEC 61400-25.



1446 The approach of the standard is to decompose the application functions into the smallest entities, which are  
1447 used to exchange information. The granularity is given by a reasonable distributed allocation of these entities  
1448 to dedicated devices (IED). These entities are called logical nodes (e.g., a virtual representation of a rotor  
1449 class, with the standardized class name WROT). The logical components are modeled and defined from the  
1450 conceptual application point of view. Several parts of logical components build higher level logical  
1451 components. A logical component is always implemented in one IED.

1452 Part IEC 61400-25-5 introduces the conformance testing procedure for wind power plants. Conformance  
1453 testing shall be customized for each device under test based on the capabilities identified in the PICS, PIXIT  
1454 and MICS provided by the vendor. When submitting devices for testing, the following shall be provided:

- 1455 • Device for testing.
- 1456 • Protocol Implementation Conformance Statement (PICS).
- 1457 • Protocol Implementation eXtra Information for Testing (PIXIT) statement.
- 1458 • Model Implementation Conformance Statement (MICS).
- 1459 • Instruction manuals detailing the installation and operation of the device.

1460 The requirements for conformance testing fall into two categories:

- 1461 a) static conformance requirements (define the requirements the implementation shall fulfill).
  - 1462 b) dynamic conformance requirements (define the requirements that arise from the protocol used for a  
1463 certain implementation).
- 1464

#### 1465 10.4.2.4 IEC 62056

1466 The IEC 62056 standards are the International Standard versions of the DLMS/COSEM specification and  
1467 used by the Smart Metering Standardization Mandate M/441 by the European Commission to specify  
1468 standards for additional smart metering functions and for communication architectures and protocols. The  
1469 standards also cover aspects of data security, privacy, interoperability and the link to Smart Grids. The  
1470 European OPEN meter research project was running in parallel with the Mandate and confirmed  
1471 DLMS/COSEM as the leading standard for smart metering, supporting all energy types, all interfaces and all  
1472 communication media.

1473 In the TR “DLMS/COSEM Conformance Testing Process” methods and processes for conformance testing  
1474 and certification of metering equipment implementing the DLMS/COSEM specification for meter data  
1475 exchange are specified by the DLMS User Association.

1476 The DLMS/COSEM conformance testing process is described in the Figure 33.

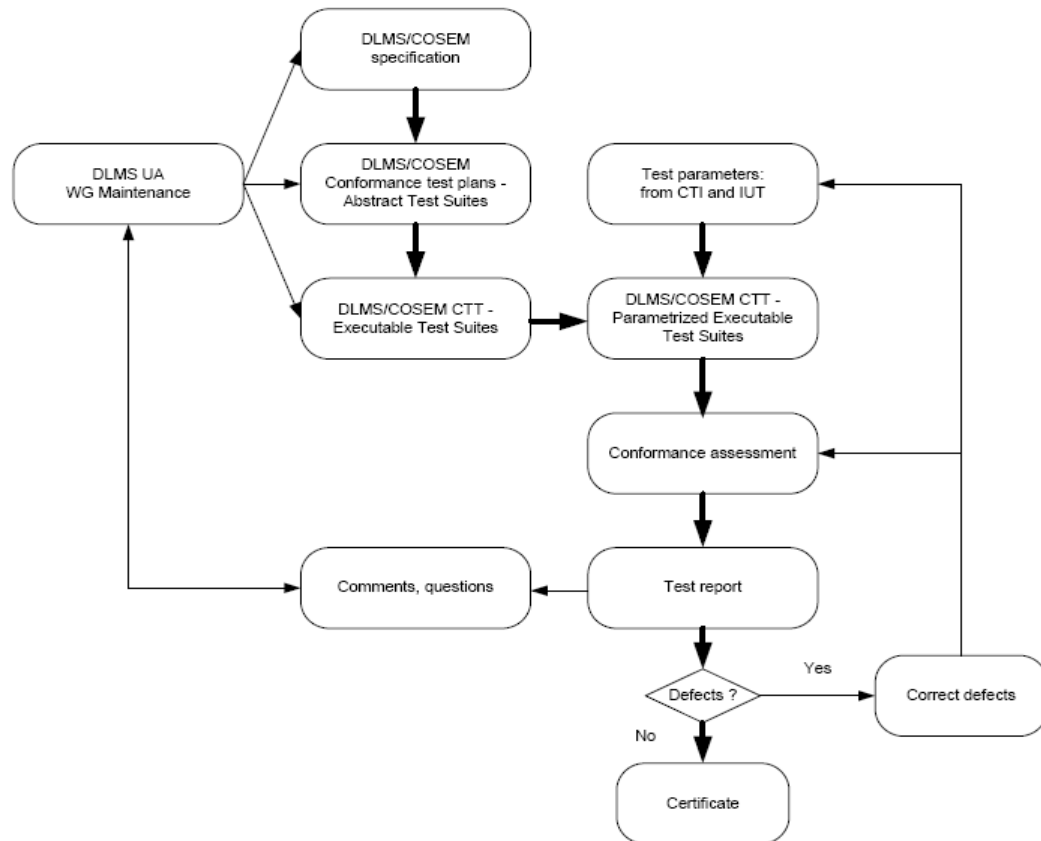

Figure 33 DLMS/COSEM conformance testing process

1477  
1478  
1479

1480 The conformance test plans – Abstract Test Suites – describe, at the level of abstraction, the test to be  
1481 performed. Test suites include test cases falling in the following categories (the list is not exhaustive):

- 1482 • capability tests.
- 1483 • behavior tests of valid behavior (positive tests).
- 1484 • behavior tests of syntactically invalid or inopportune behavior (negative tests).
- 1485 • test focusing on PDUs (protocol data units) sent to and received from the IUT.
- 1486 • test related to each protocol phase.
- 1487 • timing.
- 1488 • PDU encoding variations.
- 1489 • variations in values of individual parameters and/or combination of parameters.

1490 The DLMS/COSEM conformance test tool (CTT) is an implementation of the abstract test suites in the form  
1491 of executable test suites. It can perform the following:

- 1492 • the selection of test cases.
- 1493 • the parameterization of the test cases.
- 1494 • the execution of test cases; and
- 1495 • the production of the Conformance test report and a Conformance log.

1496 The conformance assessment process (see Figure 34) is the complete process of accomplishing all  
1497 conformance testing activities necessary to enable the conformance of the IUT to be assessed. It may be  
1498 performed by an identifiable part of a manufacturer's organization (self-testing), a user or an independent  
1499 test house (third party testing).

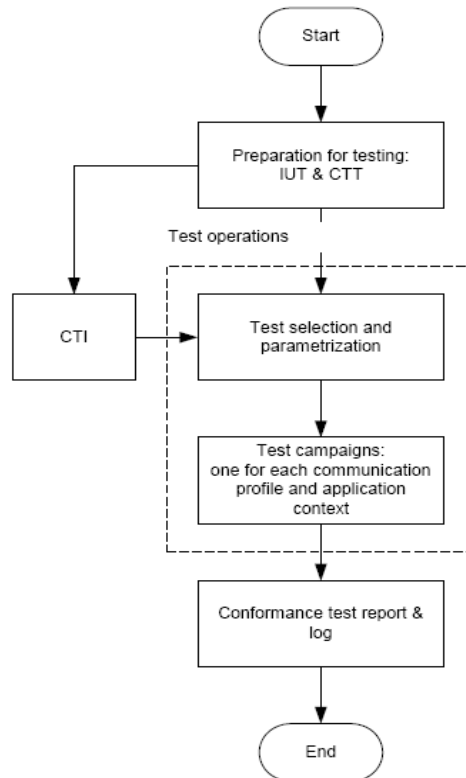

Figure 34 DLMS/COSEM conformance assessment process overview

The preparation for testing phase involves:

- the preparation of the IUT.
- the production of the CTI (conformance test information) file.
- the preparation of the CTT.

The test operations include:

- review of the CTI.
- test selection and parameterization.
- one or more “test campaigns”.

At the end of each test campaign, a conformance test report is produced.

The certification process consists of examining conformance test reports and publication of Certificates.

The quality program includes handling comments and questions and initiating the maintenance of the specification, the conformance test plans and / or the CTT as appropriate.

#### 10.4.2.5 Common Information Model

The Common Information Model (CIM) is an abstract information model that provides data understanding through the identification of the relationships and associations of the data within a utility enterprise. This enhanced data understanding supports the exchange of data models and messages and increases the ability to integrate applications both within the enterprise and with trading partners. These trends go beyond exchanges or updates of network models to the exchange of specific dynamic data within transactional messages in a real-time environment.

The CIM companion standards below provide extensions and specifications that, when used in conjunction with the CIM models, provide a framework for the exchange of static models, transactional messages and full enterprise integration.

- IEC 61970 – For power system modeling and energy utility data exchange including EMS, topology, wires, SCADA, etc.

- IEC 61968 – For power system modeling related to DMS, assets, work, GIS, metering and application messaging.
- IEC 62325 – Modeling for energy markets with support for both North American and European markets.

CIM related Interoperability Test are actually organized by ENTSO-E and UCAlug (UCA International Users Group).

#### 10.4.2.6 ENTSO-E Interoperability (IOP) Tests <sup>10</sup>

ENTSO-E plays a leading role in organizing CIM interoperability tests related to both grid model and market exchanges. There are at least two types of interoperability tests:

- Tests to validate a CIM standard as a part of the standard's development process.
- Tests to validate the conformance of available software solutions with an approved standard.

The ENTSO-E CIM interoperability tests facilitate the development of CIM standards for both ENTSO-E and IEC. These IOP tests are tailored to ensure adequate representation of important business requirements for TSOs. The tests are also designed to allow vendors to verify the correctness of the interpretation of the CIM standards.

The tests directly support ENTSO-E processes towards achieving the objectives of the EU Third Energy Package.

Since 2009, ENTSO-E has organized four large-scale IOP tests for grid models exchange based on IEC 61970<sup>11</sup>.

In 2012, ENTSO-E organized the first IOP on CIM for energy market and began the use of IOPs related to the CIM for European market style (IEC 62325<sup>12</sup>).

#### 10.4.2.7 UCA User Group CIM Interoperability Test

The UCA CIM Interop Working Group evaluates the interoperability of EMS and third-party vendor products through the administration of formal test procedures. Interoperability testing proves that products from different participant vendors can exchange information based on the use of the IEC standards. These standards include various parts of the IEC 61970, IEC 61968 and IEC 62325 family of standards. The 2011 UCAlug Comprehensive Interoperability Test was designed to test various components of the CIM and IEC 61850.

The IEC 61968-13<sup>13</sup> and IEC 61968-4 on-site IOP tests were hosted by EDF R&D, while in parallel remote IOP tests were conducted for part IEC 61968-3, IEC 61968-6. All these tests leveraged IEC 61968-11 and IEC 61970-301 CIM information model.

#### 10.4.2.8 ISO/IEC 15118 (Vehicle to Grid)

FP7 PowerUp, where ETSI was partner, aimed to develop the Vehicle-To-Grid (V2G) interface for Electric Vehicle charging, involving a full development cycle of physical/link-layer specification, charging control protocol design, prototyping, conformance testing, field trials, and standardization.

WP6 of the project deals with conformance and interoperability testing for the V2G standard interface based on ISO/IEC 15118-2.

<sup>10</sup> <https://www.entsoe.eu/major-projects/common-information-model-cim/interoperability-tests/>

<sup>11</sup> <https://www.entsoe.eu/major-projects/common-information-model-cim/cim-for-grid-models-exchange/standards-iop-tests/>

<sup>12</sup> <https://www.entsoe.eu/major-projects/common-information-model-cim/cim-for-energy-markets/standards-iop-tests/>

<sup>13</sup> "[http://testing.ucaiug.org/IOP\\_Registration/2011%20CIM-61850%20IOP/IOP%20Reports/CDPSM%202011%20IOP%20Final%20Report.pdf](http://testing.ucaiug.org/IOP_Registration/2011%20CIM-61850%20IOP/IOP%20Reports/CDPSM%202011%20IOP%20Final%20Report.pdf) DRAFT"

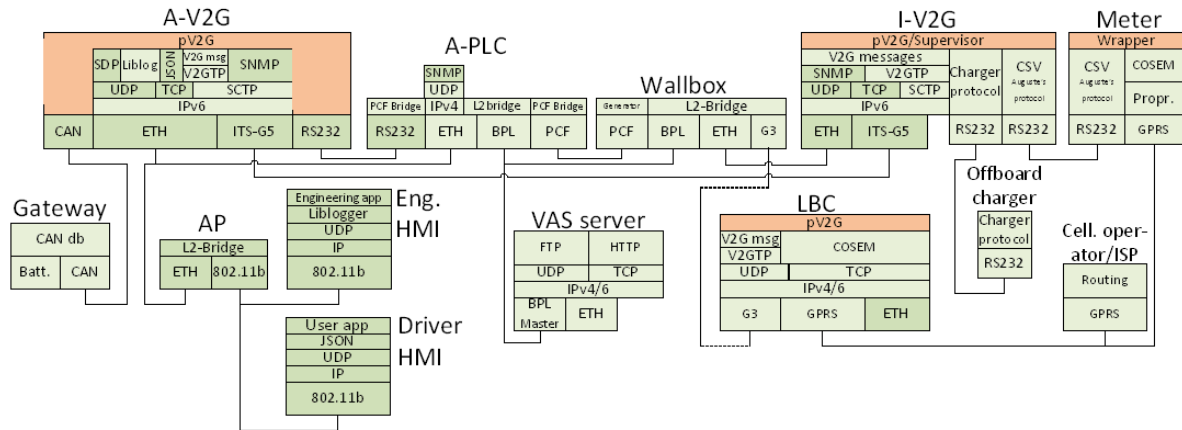
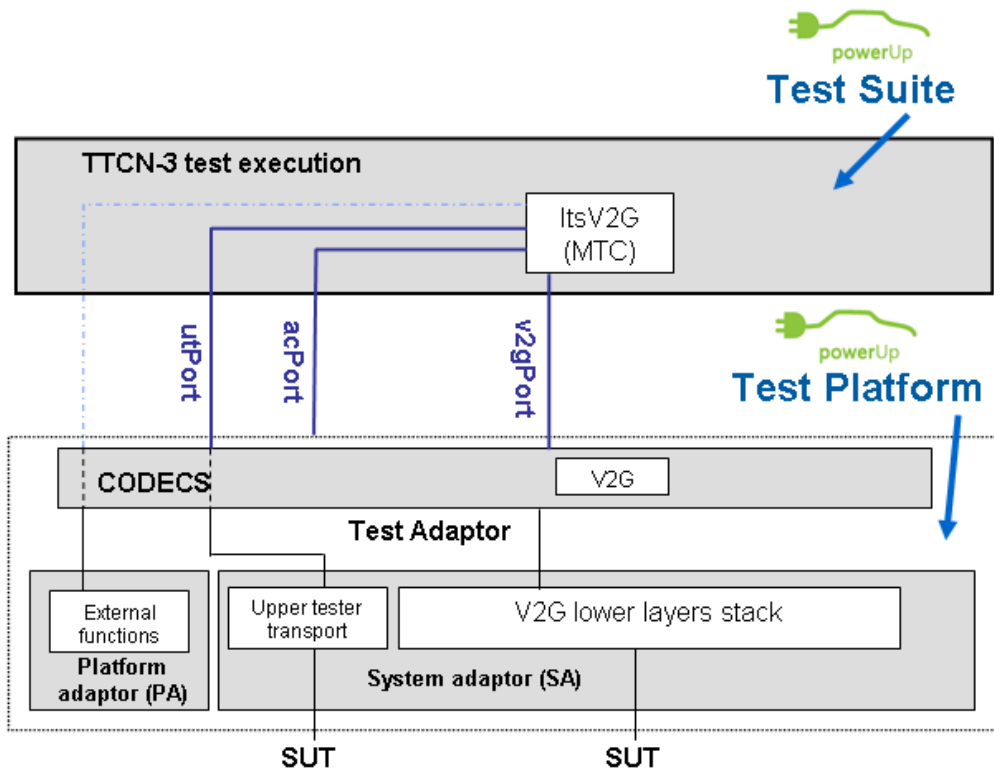

Figure 35 FP7 PowerUp System Architecture

For more details on FP 7 PowerUp Conformance testing, refer to the PowerUp Deliverable 6.1 “V2G Conformance Test Specifications”.

The FP7 PowerUp project has developed the V2G conformance test platform which provides a reliable set of software and hardware that can be used to execute the V2G TTCN-3 abstract test suite.



TTCN-3 ports      TTCN-3 external functions

Figure 36 TTCN-3 test suite and test platform

The purpose of the FP7 PowerUp WP6 was also to develop an interoperability testing framework for V2G interface, based on the standard ISO/IEC 15118-2.

Multi-vendor compatibility is crucial for the success of V2G technology, so that the recharging of any fully electric vehicle brand could be controlled by any electric network in the European Union. Because of the large number of possible interaction types between various vendors, namely the multiple of automotive-side and grid-side implementations, such interoperability testing requires careful and thorough methodology. The

1586 methodology followed is based on an ITS framework specified in the ETSI recommendation EG 202 798,  
1587 offering a base for further interoperability test specifications.

1588 The V2G Interoperability framework includes the “Equipment under test” identification, the Test bed  
1589 specification and the development of Test Descriptions.

1590

#### 1591 **10.4.2.9 ETSI**

1592 One main aim of standardization is to enable interoperability in a multi-vendor, multi-network, multi-service  
1593 environment. Many ETSI Technical Bodies rely on the following three pillars of good practice to help realize  
1594 interoperable standards:

- 1595 • Standards engineering.

1596 Standards need to be designed for interoperability from the very beginning. Well-specified, unambiguous  
1597 requirements can contribute to the overall technical quality of a standard, thus minimizing the potential of  
1598 non-interoperable products.

- 1599 • Validation.

1600 Most standards are complex documents (or sets of documents) and, even when great care has been  
1601 taken in the drafting stages, ambiguities, incompleteness and even errors will still occur. Feedback from  
1602 validation activities is a very good way to remove these inconsistencies and improve the overall quality of  
1603 the documentation.

- 1604 • Testing.

1605 The development of standardized test specifications is an integral part of the ETSI strategy for ensuring  
1606 interoperability. Reflecting the principle: test the components first, then test the system, ETSI focuses on  
1607 the development of two types of test specifications:

- 1608 - conformance test specifications.
- 1609 - interoperability test specifications.

1610 The ETSI White Paper No. 3 “Achieving Technical Interoperability” presents an overview of the approach of  
1611 ETSI to ensure interoperable standards. It provides a short description of the meaning of Technical  
1612 Interoperability followed by an analysis of the implications that this has on standardization.

1613 ETSI TS 102 237-1 gives general guidance on the specification and execution of interoperability tests for  
1614 communication systems in Next Generation Networks (NGN). It provides a framework within which  
1615 interoperability test specifications for a wide range of product types can be developed.

1616 The main components of the guidelines are as follows:

1617 Development of interoperability test specifications, including:

- 1618 • identification of interoperable functions.
- 1619 • identification of abstract architectures.
- 1620 • specification of interoperability test suite structure and test purposes.
- 1621 • specification of interoperability test cases.

1622 The testing process, including:

- 1623 • test planning.
- 1624 • specification of test configurations.
- 1625 • execution of the tests.
- 1626 • logging results and producing test reports.

1627



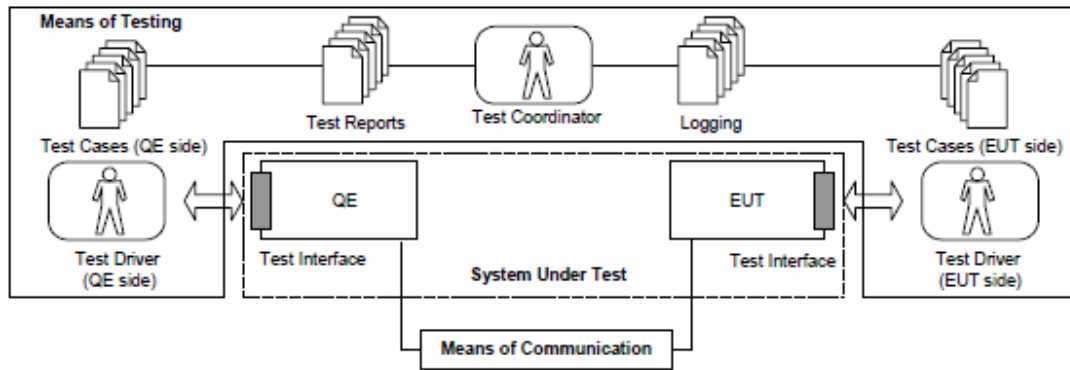

Figure 37 Illustration of main concepts according to ETSI TS 102 237-1

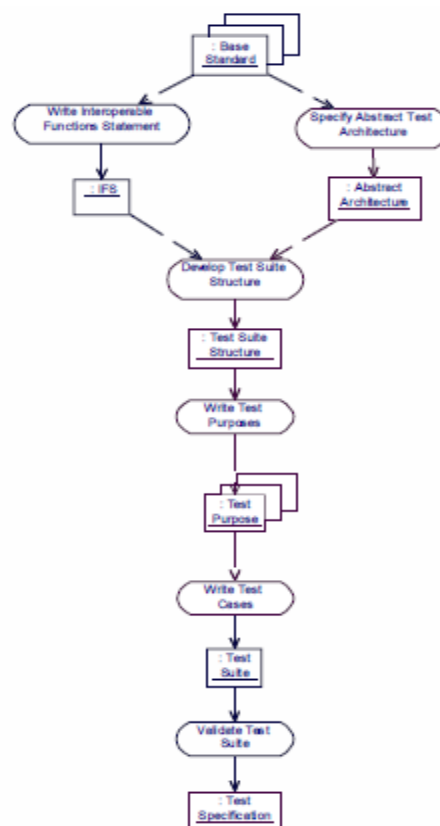

Figure 38 Developing an interoperability test specification according to ETSI TS 102 237-1

Further information can be found here: <http://portal.etsi.org/CTI/Home.asp>

### 10.5 User Groups

The following main User Groups are interested in defining Interoperability testing procedures.

- DLMS UA (Device Message Language Specification User Association).
- UCAlug (UCA International Users Group).
- CIMug (CIM User Group).
- European Network of Transmission System Operators for Electricity (ENTSO-E).
- IEC60870-5 User Group.

1644 **10.5.1 DLMS UA (Device Message Language Specification User Association)**

1645 In creating generic and compatible communication objects, the DLMS UA enables the integration of diverse  
1646 systems and thus simplifies operational and commercial processes. This will raise the efficiency in different  
1647 business sectors remarkably, independently of the brand of meters.

1648 Objectives of the DLMS UA:

- 1649 • In applying standards for compatible communication protocols DLMS UA helps to secure investment in  
1650 new generations of meters and new applications.
- 1651 • Identification of possible applications and definition of parameters to ensure compatibility.
- 1652 • Active representation of members in European and international standards organizations, having the task  
1653 of standardizing communication protocols.
- 1654 • Lobbying through potential users and standards organizations.
- 1655 • Definition and supervision of amendments of technical specifications in co-operation with national and  
1656 international standards organizations.
- 1657 • Granting of a DLMS label for compatible products.

1658 The DLMS User Association forms its own Working Groups to work out specific tasks on behalf of the  
1659 Management Committee. At the time being, the Working Groups *WG Maintenance* is active, the *WG*  
1660 *Conformance Testing*, *WG Application and Implementation* and *WG Value Added Services* have finished  
1661 their task.

1662 Conformance testing is a verification that an implementation meets the formal requirements of the standard.  
1663 During the test phase the implementation is referred to as the Implementation Under Test (IUT).

1664 The primary objective of conformance testing is to increase the probability that different product  
1665 implementations actually interoperate.

1666 No amount of testing can give a full guarantee of successful interworking. The exhaustive testing of every  
1667 possible aspect of protocol behavior is unrealistic and impractical for technical and economical reasons.

1668 Conformance testing can however give a reasonable degree of confidence that an implementation which  
1669 passes the test, will comply with the requirements in communication with other systems.

1670 As such, conformance testing can be regarded as a prerequisite for interworking.

1671 To enable claiming compliance of server implementations to the DLMS/COSEM specification, the DLMS UA  
1672 provides a conformance test process.

1673

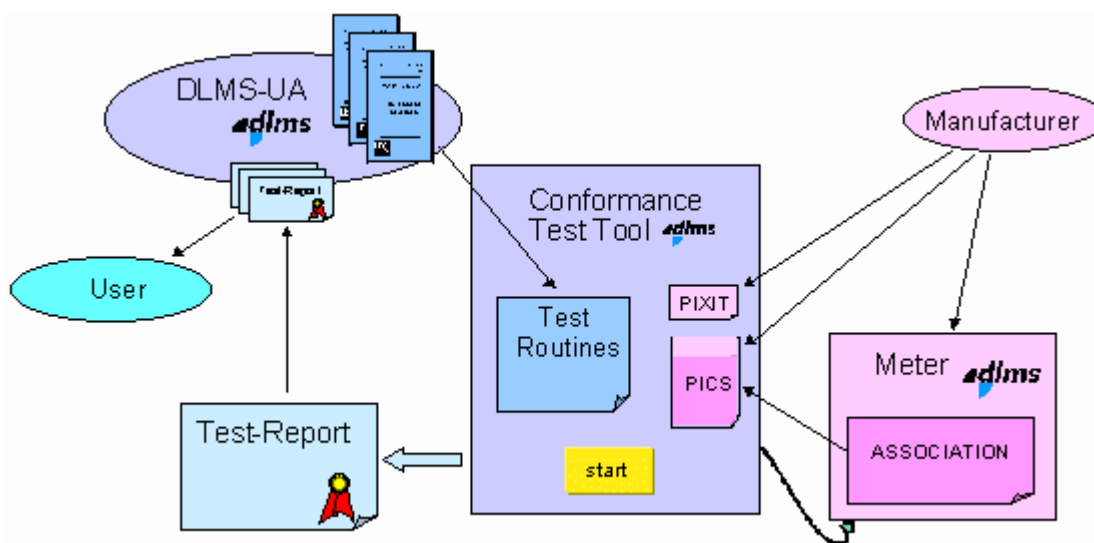

1674

1675 **Figure 39 Conformance Testing according to DLMS UA**

1676 The conformance testing process is described in detail in the DLMS UA Yellow book.

1677 An excerpt can be downloaded under <http://www.dlms.com/documentation/index.html>

1678

1679 **10.5.2 UCAIug (UCA International Users Group)**

1680 **10.5.2.1 UCAIug Organization**

1681 The UCA International Users Group is a not-for-profit corporation consisting of utility users and supplier  
1682 companies that is dedicated to promoting the integration and interoperability of electric/gas/water utility  
1683 systems through the use of international standards-based technology. It is a User Group for IEC 61850, the  
1684 Common Information Model – Generic Interface Definition (CIM/GID as per IEC 61970/61968), advanced  
1685 metering and demand response via OpenADR.

1686 Mission of the UCAIug is to enable utility integration through the deployment of open standards by providing  
1687 a forum in which the various stakeholders in the utility industry can work cooperatively together as members  
1688 of a common organization to:

- 1689 • Influence, select, and/or endorse open and public standards appropriate to the utility market based upon
- 1690 the needs of the membership.
- 1691 • Specify, develop and/or accredit product/system-testing programs that facilitate the field interoperability of
- 1692 products and systems based upon these standards.
- 1693 • Implement educational and promotional activities that increase awareness and deployment of these
- 1694 standards in the utility industry.

1695 The Users Group is a focus group to assist users and vendors in the deployment of standards for real-time  
1696 applications for several industries with related requirements. The Users Group does not write standards and  
1697 shall, where appropriate, work closely with those bodies that have primary responsibility for the completion of  
1698 standards (notably IEC TC 57: Power Systems Management and Associated Information Exchange).

1699 Note that the Users Group is working on many areas of interest for different users where standard bodies  
1700 may not yet be active or where the interests of users go beyond the purview of the presently identified  
1701 standards (such as the completion of users guides, industry education, transfer of technology, marketing  
1702 support, identification of users' needs and industry demonstrations to prove concepts).

1703

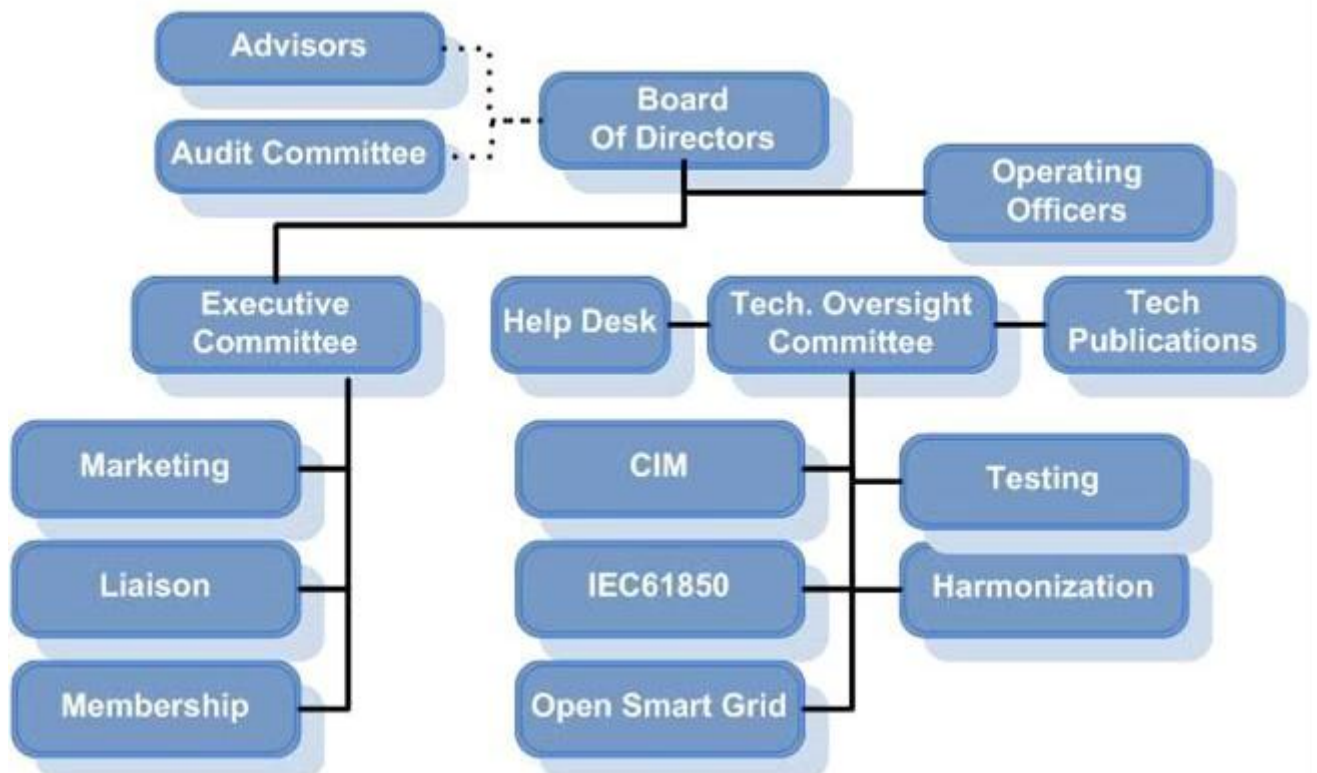

1704

1705

1706

**Figure 40 UCAIug Organization Chart**

Link: [www.ucaiug.org](http://www.ucaiug.org)

1707

### 10.5.3 CIMug (CIM User Group)

1708  
1709  
1710  
1711  
1712

The CIM Users Group (CIMug) was formed in 2005, as a subgroup of the UCA International Users Group, to provide a forum in which users, consultants, and suppliers could cooperate and leverage the IEC CIM international standards to advance interoperability across the utility enterprise. The primary purpose is to share technology basics, best practices and technical resources while Advancing Interoperability for the Utility Enterprise.

1713  
1714  
1715

The CIM Users Group is dedicated to managing and communicating issues concerning the TC57 IEC 61970 and IEC 61968 standards and to serving as the primary means for developing consensus and consistency across the industry.

1716

The CIM User Group Goals are:

1717  
1718  
1719  
1720  
1721  
1722  
1723  
1724

- Provide liaison with other standards groups and assess the impact of other standards on the form, scope and content of the CIM.
- Provide a central Repository for CIM issues, models, messages and expertise.
- Provide a central Repository for CIM-based message payload designs and schemas.
- Promote the CIM and CIM related standards.
- Provide a single point of contact for CIM Model Management and issue resolution.
- Provide awareness of CIM products and implementations.
- Provide a Help Desk for members to obtain timely and accurate answers.

1725

1726

### 10.5.4 European Network of Transmission System Operators for Electricity (ENTSO-E)

1727  
1728

Being the body of transmission system operators of electricity at European level, ENTSO-E's mission is to promote important aspects of energy policy in the face of significant challenges:

1729  
1730  
1731  
1732  
1733  
1734  
1735  
1736

- Security - pursuing coordinated, reliable and secure operations of the electricity transmission network.
- Adequacy - promoting the development of the interconnected European grid and investments for a sustainable power system.
- Market - offering a platform for the market by proposing and implementing standardized market integration and transparency frameworks that facilitate competitive and truly integrated continental-scale wholesale and retail markets.
- Sustainability - facilitating secure integration of new generation sources, particularly growing amounts of renewable energy and thus the achievement of the EU's greenhouse gases reduction goals.

1737  
1738  
1739  
1740  
1741  
1742

In order to reach these objectives, seamless and efficient information exchanges are necessary at various stages, between an increasing number of companies – TSOs, DSOs, generators etc. To ensure that the IEC CIM standards are developed in line with TSO requirements, ENTSO-E established liaisons with IEC TC 57/WG13 (the group dealing with CIM for transmission) and IEC TC57/WG16 (the group responsible for CIM for Energy Market). In addition, ENTSO-E is actively cooperating with the CIM User's Group and UCAI User's Group to exchange information within the CIM community.

1743

1744

### 10.5.5 IEC60870-5 User Group Mail list

1745  
1746  
1747  
1748  
1749  
1750

This mail list was established as a result of discussions at the IEC TC 57 Working Group 03 meeting in Lucerne (April 1998) concerning the likely interoperability of products claiming to conform to IEC 60870-5-101, the desire of users to obtain "plug and play" products, and how best to help users and suppliers interpret the standard in a consistent way. The objective of this mail list is to create a place implementers and users of IEC 60870-5 can discuss different interpretations of the specifications in an effort to establish a consensus opinion on each topic.

1751  
1752

This mail list is open to anyone with an interest in IEC 60870-5 and there are no membership fees. Topics regarding any of the profiles (-101, -102, -103, and/or -104) may be submitted to the mail list.

1753  
1754  
1755

Anyone subscribing to the IEC 60870-5 User Group Mail list is welcome to respond to a message. The information provided is simply helpful advice and no liability for the correctness of the information is given by the author of each message or by the administrator of this mail list.

1756  
1757

Link: <http://www.trianglemicroworks.com/iec60870-5>

1758 **11. Assessment related to the improvement of Interoperability in the context of Smart**  
1759 **Grid standardization**

1760 Along with the initial task of delivering the report named “*Methodologies to facilitate Smart Grid system*  
1761 *interoperability through standardization, system design and testing*”, SG-CG WGI took the decision to prepare  
1762 and circulate two questionnaires, seeking information and/or collaboration on the topic improvement of  
1763 Interoperability in the context of Smart Grid standardization.

1764

1765 **11.1 Questionnaire 1 related to improvement of Interoperability in the context of Smart Grid**  
1766 **standardization**

1767 **Executive Summary**

1768 In Spring 2014 SG-CG- WGI launched a consultation asking for information and/or collaboration on the topic  
1769 improvement of Interoperability in the context of Smart Grid standardization, in order to assist in the  
1770 preparation of the SG-CG WGI Report.

1771 The main goal of this survey was to confirm whether or not the vision and methodology carried out by SG-  
1772 CG WGI was aligned with the work already in place for this subject in certain selected standardization  
1773 bodies, technical committees and other organizations involved in Smart Grid.

1774 SG-CG WGI used the summary of the survey as an input for defining the methodology of profiles and testing  
1775 methods, including conformance testing, to achieve interoperability.

1776 The questionnaire was issued to all key stakeholders by the CLC/BT in particular to IEC TC 8, TC 13, TC  
1777 57, TC69 and TC 205, ETSI, ENTSO-e, NIST, and IS-INNOTEK, DLMS, Eurelectric, EDSO4SG, UCAIug,  
1778 UTC/EUTC.

1779 The Questionnaire and a summary of all received answers is available as a separate annex.

1780

1781 **11.1.1 Questionnaire 1 Results and Conclusions**

1782 **11.1.1.1 Analysis Methodology**

1783 Questions were grouped into the following categories:

- 1784 a) Identification and confirmation of contacts for cooperation with SG-CG WGI.  
1785 b) System Interoperability Profiles related questions.  
1786 c) Conformance Testing Procedures related questions.  
1787

1788 **11.1.1.2 Summary of Results**

1789 **Q1. Identification and confirmation of contacts for cooperation**

- 1790 • 7 answers have been received in response to the questionnaire:  
1791 CLC/TC57, CLC/TC 205, IEC/TC13 WG14, IEC/TC57 WG10-WG14-WG15, WG16, EDSO4SG, ENTSO-  
1792 E, EE-Bus Initiative, IS-INOTEK.
- 1793 • Each entity which responded provided a contact person.  
1794 A detailed summary of all the received answers (EXCEL file) is available as a separate Annex.  
1795

1796 **Q2. System Interoperability Profiles**

- 1797 • The following entities confirmed they are working on System Interoperability:  
1798 - IEC TC 57 WG10- WG14- WG 16 - WG19 - WG21.  
1799 - ENTSO-E AhG IEC 61850.  
1800 - ENTSO-E CIM.  
1801 - IEC TC 13 WG 14.  
1802

1803 **Q3. Conformance Testing Procedures**

- 1804 • The following entities confirmed they are working on the definition of Conformance Testing Procedure:  
1805 - IEC TC 57 WG10- WG14.



- DLMS User Association reported about a published Conformance testing process and the existence of test plans and test tools to support conformance testing.

### 11.1.1.3 Conclusions

There were a sufficient number of answers coming from different entities. The number of responses approved the common interest in efforts to enhancing system interoperability.

Most of the answers are related to standards that have a strong semantic layer, like IEC-61850 and CIM based standards (IEC61970, IEC61968, IEC62325, IEC62746, IEC62361). The interest in these standards confirms the relevance of the semantic level in seeking to achieve interoperability at functional level.

It was recognized that stakeholder views concerning definitions, profiles, conformance testing procedures and test cases vary. A common agreed methodology how to enhance interoperability using profiles, conformance and interoperability testing will help to align ongoing activities across the different stakeholders. Furthermore the need to instruct people involved on Smart Grid deployment about the use of the common agreed methodology (including the common use of the SGAM model) seems to be appropriate.

## 11.2 Questionnaire 2 on priority where profiling is most critical / important in the context of IOP

### Background

System interoperability is one of the most important topics for achieving cost savings and time efficiency in rolling out smart grid systems. Using standards is a pre-condition for system interoperability. Smart Grid is a large and complex system, which covers five domains (according to SGAM), from generation, transmission, distribution, DER to the end consumer side. During its work, the working group identified that, on the one hand, there are multiple standards within same smart grid domain, and on the other hand, even for the same standard there are also many options available. This presents challenges for deploying systems in the context of interoperability.

The SG-CG WGI therefore launched a further consultation, asking for information on which systems in the smart grid are the most critical and important in context of interoperability. We thus asked for priority assessment of the importance of interoperability. Additionally we asked for view of the probability of improving this interoperability in reasonable time.

WGI selected systems based on the list of systems used by SGCG/SS- see Table 2 below. There was the possibility of adding other systems to the list.

1	Authentication authorization accounting system,	AAA
2	AMI system,	AMI
3	Asset and maintenance Management system,	ASM
4	Communication network management system,	CNM
5	Clock reference system,	CR
6	DER EMS and VPP system,	DERE
7	DER operation system,	DERO
8	Distribution Flexible AC Transmission Systems FACTS,	DFACT
9	DMS SCADA system,	DMS
10	Device remote configuration system,	DRC
11	Distribution Substation automation system,	DSA
12	E-mobility system,	EV
13	Feeder automation/ smart reclosing system,	FA
14	GIS system,	GIS
15	Metering back office system,	MBO

16	Marketplace system,	MP
17	EMS SCADA system,	SCADA
18	Transmission Flexible AC Transmission Systems FACTS,	TFACT
19	Trading system,	TR
20	Transmission Substation automation System,	TSA
21	WAMS Wide Area Measurement System,	WAMS
22	Weather observation and forecast system,	WO

**Table 2 WGI selected systems based on WG SS**

For easy reporting WGI developed and used an assessment tool in excel sheet format. In the tool we asked to select up five most important systems, and give each a ranking in the column “priority”. Five is the highest priority and one the lowest. For the selected systems, in the second column “chance”, one could give the points according to their view. Five is the highest probability for improving interoperability in reasonable time, and one the lowest.

### 11.2.1 Questionnaire 2 Results and analyses

30 answer forms have been received in response to the questionnaire.<sup>14</sup> In alphabetic order:

CG Automation – ZIV; Deutsche Telecom; DNV GL – Energy; E.ON; ECOS; EDSO4SG; Elforsk AB; EnBW; power grid operators; Enexis; ENTSO-E; IBERDROLA; KTH; OFFIS R&D; Ormazabal; Schneider Electric Spain; SERCOBE; SIEMENS IC-SG; Terna; TUC University; Vattenfall Eldistribution AB.

The results are as follows:

1. One subject was added by Deutsche Telecom. This subject is: “Appliance Interfaces for VPP, DER, EMS”.
2. One subject of the listed table was not mentioned. This subject is: “Distribution Flexible AC Transmission Systems FACTS”.

It should be recognized that the questionnaire gives illustrative rather than representative results.

For analyzing multiple methods are available. Different methods are considered:

1. add all the given priorities and rank the subjects accordingly.
2. rank on how many times a particular subject is mentioned.
3. add the priorities and divide them by how many times mentioned and rank the subjects accordingly.

There is no significant difference between [1] and [2]. But there is between [1] and [3]. For example if a subject is only mentioned once but the referenda give it a priority 5 then it comes on the absolute top. On the other hand if a subject is mentioned multiple times and the priorities are divided by the number of mentioned there will be a natural average where no clear deviation between subjects can be seen anymore. Therefore the method [1] has been chosen for further analysis.

### Analysis

1. Highest priority are two topics:
  - Distribution Substation automation system (DSA).
  - AMI system (AMI).

<sup>14</sup> Not all recipients have filled in their companies name. If filled in the exact text inclusive capitals is used.

- 1872 2. The next 5 high rankings are:
- 1873 - Feeder automation/ smart reclosing system (FA).
  - 1874 - DER EMS and VPP system (DERE).
  - 1875 - Transmission Substation automation System (TSA).
  - 1876 - DER operation system (DERO).
  - 1877 - Communication network management system (CNM).

1878 The total ranking is presented in Table 3.

1879

profile subject, domain		Priority	Chance to improve iop	how often mentioned
Distribution Substation automation system	DSA	77	81	22
AMI system	AMI	60	59	17
Feeder automation/ smart reclosing system	FA	38	54	13
DER EMS and VPP system	DERE	32	33	10
Transmission Substation automation System)	TSA	30	38	10
DER operation system	DERO	28	25	7
Communication network management system	CNM	27	36	9
Device remote configuration system	DRC	26	36	9
E-mobility system	EV	24	25	7
Marketplace system	MP	18	16	6
WAMS Wide Area Measurement System	WAMS	15	26	7
Authentication authorization accounting system	AAA	14	21	6
DMS SCADA system	DMS	14	30	8
GIS system	GIS	10	10	3
EMS SCADA system	SCADA	7	11	4
Metering back office system	MBO	6	9	2
Transmission Flexible AC Transmission Systems FACTS	TFACT	5	4	1
Trading system	TR	5	6	3
Clock reference system	CR	4	6	2
Weather observation and forecast system	WO	4	6	2
Appliance Interfaces for VPP, DER, EMS	AIV	3	5	1
Asset and maintenance Management system	ASM	3	2	1
Distribution Flexible AC Transmission Systems FACTS	DFACT			

1880

**Table 3 results priority assessment**

1881

1882 A graphical presentation is depicted in Figure 41

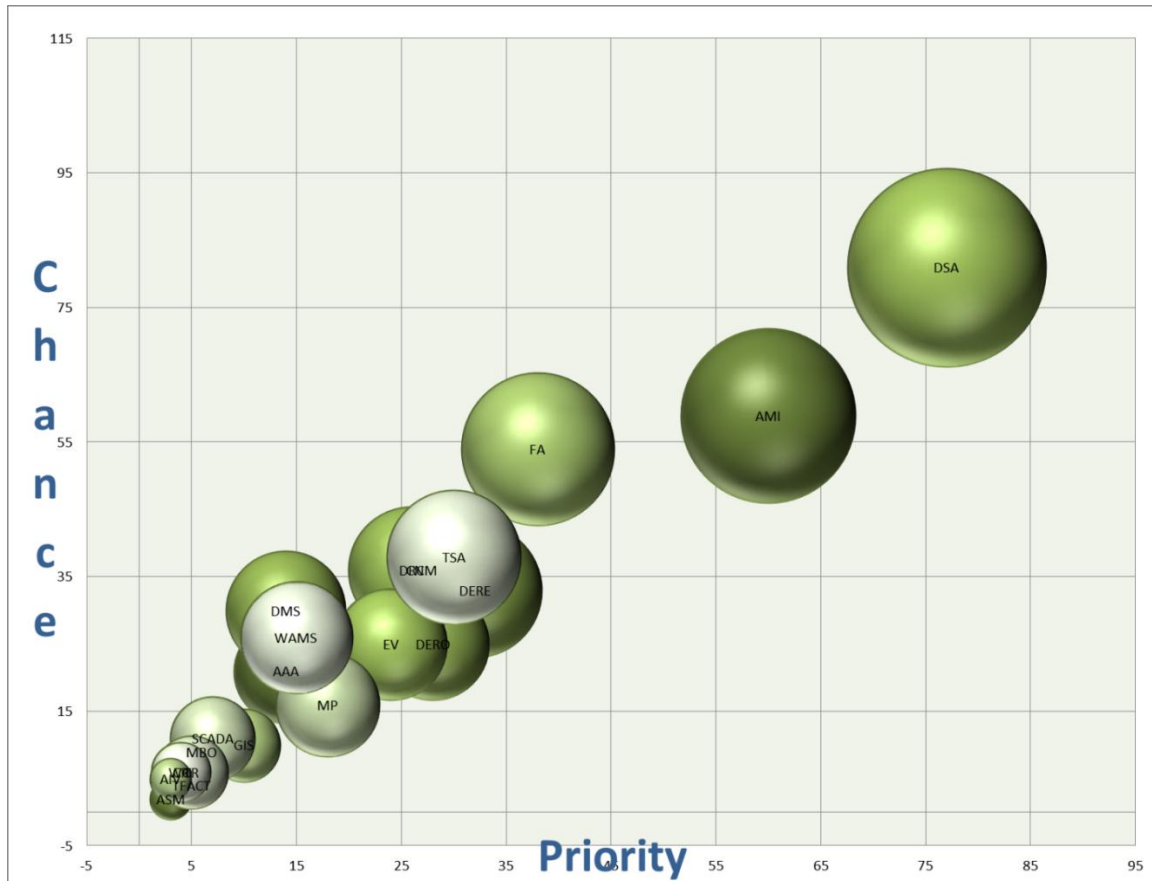

Figure 41 graphical presentation of assessment of priority<sup>15</sup>

1883

1884

1885

1886 **11.2.1.1 Conclusions**

1887

1888

1889

1890

1891

1892

1893

1894

1895

1896

1897

1898

- There were a sufficient number of answers coming from different entities. The number of responses approved the common interest in efforts to enhancing system interoperability.
- Roughly we may conclude that there are 3 groups of priority; high, medium, low priority.
- Although the highest priority two topics are ranked higher than the next 5 high rankings, it is recommended to give high priority to working on interoperability and profiling for these five topics, else they would appear within a few years also in the highest category, and it takes a lot of (throughput/elapsed) time to prepare in user groups a complete set of profiles. This way we prevent interoperability issues, while often else at the end it will be repairing interoperability issues.
- Therefore WGI recommends that Technical Committees and user groups work to enhance interoperability and to develop related profiles in the area of DSM and AMI first with the highest priority, followed or in parallel with work on the medium and low priority systems.

<sup>15</sup> The size of the bubble indicates how many times the item was mentioned.

1899

## 12. Annexes

1900

### 12.1 Terms and definitions

1901

This annex presents the Interoperability Glossary. Where possible reference is made to other sources i.e. standards, reports and other glossaries. Further explanation and background of this glossary is given in chapter 4 of this report.

1902

1903

Term	Definition	Reference
<b>Accreditation</b>	Accreditation is the independent evaluation of conformity assessment bodies against recognized standards to carry out specific activities to ensure their impartiality and competence. Through the application of national and international standards, government, procurers and consumers can have confidence in the calibration and test results, inspection reports and certifications provided.	ILAC International Laboratory Accreditation Cooperation, see 4)
<b>BAIOP</b>	Basic Application Interoperability Profile.  To reach the desired level of interoperability a BAP has to be extended for interoperability testing. The extended BAP is then referred to as Basic Application Interoperability Profile (BAIOP).	As used by WGI
<b>BAP</b>	Basic Application Profile.  A BAP is a user agreed-upon selection and interpretation of relevant parts of the applicable standards and specifications and is intended to be used as building blocks for interoperable user/project specifications.  BAPs must not have options, all selected criteria are mandatory to achieve interoperability. For implementation in projects, BAPs might be extended or refined to meet the user specific requirements.	As used by WGI
<b>Coexistence</b>	The ability of two or more devices, regardless of manufacturer, to operate independently of one another at the same communications network, or to operate together using some or all of the same communication protocols and processes, without interfering with the functioning of other devices in the same system.	Adapted from IEC TC65/920/DC, see 6)
<b>Companion Specifications</b>	Project specific companion specifications will be required to achieve product level interoperability, that specify what standards are used, what alternatives have to be taken and which options need to be supported by communication entities used in the given system.	TR 50572, see 2)
<b>Compliance</b>	Accordance of the whole implementation with specified requirements or standards. However, some requirements in the specified standards may not be implemented.  Note: most related to standards.	Adapted from TOGAF 9.1 section 48.2, see 5)
<b>Component</b>	An object used in the SG, representing part of the total SG functionality required in a specific and distinctive situation.  An object can represent hardware as well as software. Software can be seen as an integral part of a component or it can add functionality to the SG system.	As used by WGI

<b>Conformance</b>	<p>Accordance of the implementation of a product, process or service with all specified requirements or standards. Additional features to those in the requirements / standards may be included.</p> <p>All features of the standard/specification are implemented and in accordance, but some additional features are not covered by the standard/specification.</p>	Adapted from TOGAF 9.1 section 48.2, see 5)
<b>Conformance testing</b>	<p>The act of determining to what extent a single implementation conforms to the individual requirements of its base standard.</p> <p>An important condition in achieving interoperability is the correct implementation of the standards. This can be verified by conformance testing.</p> <p>Determines whether an implementation conforms to a profile as written in the PICS. The latter testing can be interoperability testing if profile covers the interoperability requirements additional to the conformance testing requirements of standards applied. Conformance testing is a prerequisite for interoperability testing.</p>	Adapted from TR 50572, see 2)  Clarification of WGI
<b>Conformity assessment</b>	<p>Processes that are used to demonstrate that a product (tangible) or a service or a management system or body meets specified requirements. Assessment may be conducted by 1st, 2nd or 3rd parties depending if the activities are performed by the vendor, the purchaser/user or by a party independent from the vendor and from the purchaser/user respectively.</p>	ISO/IEC 17000, see 8)
<b>Data integrity</b>	<p>Ability of a communications system to deliver data from its source to its destination with an acceptable and measurable residual error rate.</p>	IEC 62051, see 1)
<b>Data security</b>	<p>Prevention of one or more of the following:</p> <ul style="list-style-type: none"><li>- unauthorized access to information within a data stream;</li><li>- unauthorized alteration of information within a data stream;</li><li>- unauthorized generation of messages which could be taken as valid by the receiving equipment;</li><li>- denial of service.</li></ul> <p>See also: 'Security'.</p>	IEC 62051, see 1)
<b>Deployment of methodology</b>	<p>The way in which the IOP methodology will be implemented and applied in praxis.</p>	As used by WGI
<b>Environment</b>	<p>Surroundings in which a product or (sub)system(s) exists, including air, water, land, natural resources, chemical substances, Electromagnetic (EM) noise flora, fauna, humans and their interrelation. The environment is external to a product or (sub)system(s) considered part of the smart grid. However a product or (sub)system(s) are subject to the environment.</p>	Adapted from IEC guide 109: 2012, v3.3, see 10) and ETSI EN 300 019-1-0 V2.1.2 (2003-9), see 11)
<b>Function</b>	<p>Process which constantly or at defined intervals, automatically or on demand, performs specific activities. It is defined by its input, behavior and output.</p> <p>An application is composed of one or more functions. A function can be basic (mandatory) or optional.</p>	Adapted from TR 50572, see 2)
<b>Functional requirements</b>	<p>A statement that identifies what a device or system must accomplish to produce required behavior and/or results</p>	As used by WGI



<b>GWAC (GridWise) Interoperability Framework</b>	Also known as the GWAC Stack, addresses the different layers identifying all interfaces that can have IO issues.	GWAC, GridWise Architecture Council, see 9)
<b>Incompatibility</b>	The inability of two or more objects to work together in the same system.	Adapted from IEC TC65/920/DC, see 6)
<b>Interchangeability</b>	The ability of two or more devices or objects to be interchanged without making changes to other devices or objects in the same system without degradation in system performance.	Adapted from IEC TC65/920/DC, see 6)
<b>Interconnectability</b>	The ability of two or more devices, regardless of manufacturer, to operate with one another using the same communication protocols, communication interface.  NOTE: The devices allow data exchange without agreements about the data types. A data type conversion may be necessary.	Adapted from IEC TC65/920/DC, see 6)
<b>Interoperability (IOP)</b>	The ability of two or more networks, systems, devices, applications, or components to interwork, to exchange and use information in order to perform required functions.	Adapted from TR 50572 (Glossary), see 2)
<b>IOP certification</b>	The process that will provide a certificate by an accredited body if IOP is according to a distinct profile.	As used by WGI
<b>IOP concept</b>	Generic arrangement (principles applied) how to realize IOP in a specific situation (refer to the layers in GWAC Stack).	GWAC GridWise Architecture Council, see 9)
<b>IOP level</b>	Maturity levels explained in the SGIMM, Smart Grid Interoperability Maturity Model.	GWAC GridWise Architecture Council, see 9)
<b>IOP methodology</b>	Methods and steps that can be applied to realize Interoperability in a given situation.	To be developed by WGI. See WGI Scope and WGI Targets
<b>IOP profile</b>	An IOP profile is a document that describes how standards or specifications are deployed to support the requirements of a particular application, function, community, or context.  A profile defines a subset of an entity (e.g. standard, model, rules). It may contain a selection of Data models and Services. Furthermore a profile may define Instances (e.g. specific device types) and Procedures (e.g. programmable logics, message sequences).	As used by WGI  SGRA report, November 2012
<b>IOP testing</b>	Interoperability testing should be performed to verify that communicating entities within a system are interoperable, i.e. they are able to exchange information in a semantically and syntactic correct way. During interoperability testing, entities are tested against peer entities known to be correct. (profiles).	As used by WGI
<b>IOP testing process</b>	Describing Workflow of testing from input to output and the actual procedures, tasks and responsibilities.	As used by WGI
<b>Interworkability</b>	The ability of two or more devices, regardless of manufacturer, to support transfer of device parameters between devices having the same communication interface and data types of the application data.  NOTE: If a device is replaced with a similar one of a different manufacture, it can be necessary to reprogram the application.	IEC TC65/920/DC, see 6)

<b>Interface</b>	Point or means of interaction between two systems.	IEC 62051, see 1)
<b>MICS</b>	Model implementation conformance statement. Statement that details the standard data object model elements supported by the system or device.	IEC 61850-10, see 3)
<b>Object</b>	Entity treated in a process of design, engineering, realization, operation, maintenance, dismantling and disposal.  NOTE 1 The object may refer to a physical or non-physical "thing" that might exist, exists or did exist.	IEC 81346-1, see 13)
<b>PAP</b>	Project Application Profile.  PAPs are used in projects and are based on BAPs as building blocks, but include specific refinement to meet the project requirements. To reduce the project implementation efforts, it is desired that PAPs consist of BAPs to the highest possible extent.	
<b>PAIOP</b>	Project Application Interoperability Profile.  PAIOPs are used in projects and are based on BAIOPs as building blocks, but include specific refinement for testing to meet the project requirements. To reduce the project implementation efforts, it is desired that PAIOPs consist of BAIOPs to the highest possible extent.	
<b>PICS</b>	Protocol implementation conformance statement. Statement with the summary of the communication capabilities of the system or device to be tested.	IEC 61850-10, see 3)
<b>PIXIT</b>	Protocol Implementation eXtra Information for Testing. Statement with system or device specific information regarding the communication capabilities of the system or device to be tested and which are outside the scope of the IEC 61850 series. The PIXIT is not subject to standardization.	IEC 61850-10, see 3)
<b>Plug and Play</b>	The ability to add a new component to a system and have it work automatically without having to do any technical analysis or manual configuration.	GWAC, SGIMM, see 9)
<b>Process</b>	Logically linked sequence of tasks that enables a system to achieve particular objectives.  NOTE A process may interact with other processes. Processes may be business processes or support processes.	IEC 62055, see 12)
<b>Quality Assurance Process</b>	Working process around achieving the state of Interoperability of components, (sub)systems connected to each other (the process secures transparency and witness-ability that everything went according to the rules).	As used by WGI

<p><b>Requirement</b></p>	<p>Statement that identifies a necessary attribute, capability, characteristic or quality of a system in order for it to have value and utility to a user.</p> <p>NOTE 1 In systems engineering, a requirement can be a description of what a system must do, referred to as a Functional Requirement. A requirement may alternatively specify something about the system itself, and how well it should perform its functions. Such requirements are often called Non-Functional Requirements, or 'Performance Requirements' or 'Quality Of Service Requirements'.</p> <p>NOTE 2 One common way to document a requirement is stating what the system shall do by, for example, generating a Use Case.</p>	<p>Wikipedia</p>
<p><b>Security</b></p>	<p>Measures that protect and defend information and information systems by assuring their confidentiality, integrity, access controls, availability and accuracy.</p> <p>As defined in ISO/IEC 27002:2005 "Information security is the protection of information from a wide range of threats in order to ensure business continuity, minimize business risk, and maximize return on investments and business opportunities."</p> <p>See also "Data Security".</p>	<p>Utility AMI HAN Network System Requirements Specification, see 14)</p> <p>SGIS</p>
<p><b>Security requirements (IOP)</b></p>	<p>Methods and measures to be applied in systems connected and how these should be handled in the IOP Methodology.</p>	<p>As used by WGI</p>
<p><b>Semantic IOP issues</b></p>	<p>Semantic IOP refers to the ability of systems to transmit data with unambiguous shared meaning.</p>	
<p><b>SGAM</b></p>	<p>The Smart Grid Architecture Model, the 3D- Model for SG mapping.</p> <p>High level conceptual model of the Smart Grid developed by the M/490 Reference Architecture working group describing the main actors of the Smart Grid and their main interactions.</p>	<p>SGCG, RAWG</p>
<p><b>SGIMM</b></p>	<p>The Smart Grid Interoperability Maturity Model applied together with the GWAC Stack IOP Layers.</p>	<p>GridWise Architecture Council, see 9)</p>
<p><b>SICS</b></p>	<p>SCL Implementation Conformance Statement. Statement with the summary of the capabilities of the SCL engineering tool.</p>	<p>IEC 61850-10, see 3)</p>
<p><b>Smart Grid</b></p>	<p>Electricity network that intelligently integrates the behavior and actions of all users connected to it – generators, consumers and those that do both – in order to efficiently ensure a more sustainable, economic and secure electricity supply.</p> <p>A Smart Grid is an electricity network that can cost efficiently integrate the behavior and actions of all users connected to it – generators, consumers and those that do both – in order to ensure economically efficient, sustainable power system with low losses and high levels of quality and security of supply and safety.</p>	<p>EURELECTRIC (modified)</p> <p>Glossary TR 50572, see 2)</p> <p>SGCG matrix of terms</p>
<p><b>Smart Grid Application (Domain)</b></p>	<p>The different (sub) systems that can be identified where SG technologies are applied, i.e.: Generation, Transmission, Distribution, DER and Customer premises.</p>	<p>FSS Report and SGRA Report</p>

<p><b>Standard type 1</b></p> <p><b>Standard type 2</b></p> <p><b>Standard type 3</b></p>	<p>Type 1 - Requirement Standards are high level requirement standards, neutral from technology. Those requirements do not provide technical implementation options. So WGI uses the term Standard / Specification for type 1 standards.</p> <p>Type 2 - Implementation Standard - Implementation option standards describe many specific implementation options depending on domain and technologies used. So WGI is using the term Profile as defined by WG methods.</p> <p>Type 3 - To achieve interoperability – it is often required to limit (profile) the implementation options provided by Type 2 standards. WGI is using the term Implementation profile for those type 3 standards.</p>	SGCG - WG SGIS
<p><b>Subsystem</b></p>	Part of the total system which contributes to a certain functionality.	As used by WGI
<p><b>Syntactic IOP Issues</b></p>	Syntactic interoperability is a prerequisite for semantic interoperability, it refers to packaging and transmission mechanisms for data.	As used by WGI
<p><b>System</b></p>	<p>Set of interrelated objects considered in a defined context as a whole and separated from their environment performing tasks under behave of a service.</p> <p>A typical industry arrangement of components and systems, based on a single architecture, serving a specific set of use cases.</p>	Adapted from IEC 81346-1, see 13)  FSS definition
<p><b>Technical Requirements</b></p>	Specify the technical characteristics of single component/object and/or single (sub)systems and/or specify the way systems exchange information and interact (control or are controlled).	As used by WGI
<p><b>Test specifications</b></p>	Document describing the requirements of testing process and specific tests to be performed.	As used by WGI
<p><b>TICS</b></p>	Technical Issues Conformance Statement. Statement with device specific information regarding the implemented technical issues detected after publication of the standard. The TICS is not subject to standardization.	IEC 61850-10, see 3)

1904

1905

## 12.2 Abbreviations

API	Application Programming Interfaces
ASN.1	Abstract Syntax Notation One
ATM	Abstract Test Method
ATS	Abstract Test Suite
BAIOP	Basic Application Interoperability Profile
BAP	Basic Application Profile
CDD	Component Data Dictionary (IEC / SC 3D)
CEN	The European Committee for Standardization
CENELEC	European Committee for Electro technical Standardization
CIM	Common Information Model
CIMug	CIM User Group
CIS	Component Interface Specifications
COSEM	Companion Specification for Energy Metering
CSN	Concrete Syntax Notation
CSP	Concentrated Solar Power
CTI	Conformance test information
CTT	Conformance test tool
DER	Distributed Energy resources
DIN	Deutsches Institut für Normung
DLMS	Device Language Message specification
DMS	Distribution Management System
DSO	Distribution System Operator
DUT	Device Under Test
EC	European Commission
EMC	Electro Magnetic Compatibility
EMS	Energy Management System
ENTSO-E	European Network of Transmission System Operators for Electricity
EBSII	European Business System Integration and Interoperability
ESO	European Standard Organization
Ethernet	Common computer-networking components
ETSI	European Telecommunications Standards Institute
EUT	Equipment Under Test
EV	Electric Vehicle
FSS	(Working Group) First set of standards
FTP	File transfer protocol
GID	Generic Interface Definition
GIS	Geographic Information System
GridWise	Project to modernize the US electric grid system
GSM	Global System for Mobile Communications (G2)

GWAC	GridWise Architecture Council
HBES	Home and Building Electronic System
HES	Head-End System
HTML	HyperText Markup Language
ICS	Implementation Conformance Statement
ICT	Information and Communication Technology
IEC	International Electro technical Commission
IECEE	International Electro technical Commission for Electrical Equipment
IED	Intelligent Electronic Devices
IEEE	Institute of Electrical and Electronics Engineers
IETF	Internet Engineering Task Force
IFS	Interoperable Function Statement
ILAC	International Laboratory Accreditation Cooperation
IOP	Interoperability
IP(v6)	Internet Protocol version 6
ISO	International Organization for Standardization
ISO/OSI	Open Systems Interconnection Reference Model
IT	Information Technology
ITS	Intelligent Transport Systems
ITU	International Telecommunication Union
IUT	Implementation under test
MICS	Model Implementation Conformance Statement
MoC	Means of Communication
MoT	Means of Test
NGN	Next Generation Networks
NWIP	New Work Item Proposal
OpenADR	Open Automated Demand Response
PDU	Protocol data units
PAIOP	Project Application Interoperability Profile
PAP	Project Application Profile
PICS	Protocol Implementation Conformance Statement
PIXIT	Protocol Implementation eXtra Information for Testing
PPP	Point-to-Point Protocol
PV	Photo Voltaic
QE	Qualified Equipment
RAWG	Reference Architecture Working Group under the CEN/CENELEC/ETSI SGCG
SCADA	Supervisory Control And Data Acquisition
RP	Reference Point
SAS	Substation Automation Systems
SDLC	System development life cycle



SGAM	Smart Grid Architecture Model
SG-CG	Smart Grid Coordination Group
SGIMM	Smart Grid Interoperability Maturity Model
SGIS	Smart Grid Information Security
SOAP	Simple Object Access Protocol
SUT	System Under Test
TC	Technical Committee
TCP	Transmission Control Protocol
TCP/IP	Communication protocol for the internet.
TD	Test Description
TP	Test Purpose
TR	Technical Report
TS	Technical Specification
TSO	Transmission System Operator
TSS&TP	Test Suite Structure and Test Purposes
TTCN-3	Testing and Test Control Notation version 3
UCAIug	Unified Communication Architecture International Users Group
UDP	User Datagram Protocol
UML	Unified Modeling Language
V2G	Vehicle-To-Grid
WG FSS	Working Group First set of standards within the SG-CG
WG RA	Working Group Reference Architecture within the SG-CG
WG SGIS	Working Group SGIS within the SG-CG
WG SP	Working Group Sustainable Processes within the SG-CG
WGI	Working Group Interoperability
WiFi	Technology that allows an electronic device to exchange data wirelessly
XML	Extensible Markup Language

1907

1908

1909 **12.3 Example: Smart Grid Interoperability Specification**

1910 The Smart Energy Collective (SEC) is an alliance of international and Dutch companies that agreed to  
 1911 collaborate on the development of a Universal Smart  
 1912 Energy Framework (USEF). USEF provides a Market  
 1913 based Control Mechanism (MCM) as a part of a common  
 1914 framework to interconnect these services with the  
 1915 underlying products. The framework is defined such that  
 1916 mass customization of products, services and solutions for  
 1917 niches in the market is possible without redesigning the  
 1918 market. The USEF framework provides a set of  
 1919 specifications, designs and implementation guidelines.

1920 The SEC has taken the initiative to develop this USEF  
 1921 framework because they identified the need for more  
 1922 detailed specifications and implementation guidelines in  
 1923 order to facilitate an interoperable smart grid. SEC decided  
 1924 to split the framework in a:

- 1925 • Architecture vision: describing the stakeholders, scope,  
1926 business values and capabilities.
- 1927 • Business architecture, describing the required business functionality and map it to a business model.
- 1928 • Information system architecture focuses on the interaction between all the components in all levels of the  
1929 system.

1930 In this structure the business objectives and requirements are described, as well as the high level  
 1931 architecture, the actors, a role model, use-cases, sequence diagrams etc. are described in a consistent and  
 1932 structured way.

1933 The approach SEC chosen with the USEF is in line with the recommendations by the Smart Grid  
 1934 Coordination Group WG Interoperability. USEF can be considered as (part of) a Basic Application Profile.  
 1935 Especially the Business and Functional layer of the SGAM model are defined as well as the Information  
 1936 Layer and Communication layer.

1937 Currently a test and verification framework is being developed in order to validate USEF conformity and  
 1938 interoperability. The way to validate this will be consistent with the SGCG WG Interoperability guidelines,  
 1939 meaning testing interoperability top-down and/or bottom-up using the SGAM interoperability layers.

1940 More information about SEC and USEF can be found at [www.smartenergycollective.com](http://www.smartenergycollective.com)

1941  
1942

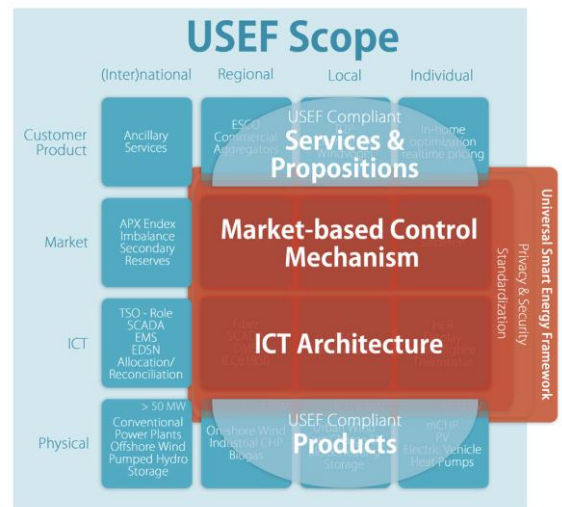

1943 **12.4 Example: Process for building an interoperable system**

1944 This section describes the process of how utilities can use standards and how vendors can use standards in  
1945 order to develop an interoperable smart grid system. Such system can be a smart meter infrastructure,  
1946 advanced distribution automation system, demand response system etc.

1947 As described in section 6 in order to build an interoperable smart grid system the authors recommend using  
1948 standards. Standards are being developed by standardization groups and/or involvement with user groups.  
1949 Manufacturers will use these standards to develop products. Utilities can ask a manufacturer during the  
1950 tender phase to demonstrate compliance of the product that the manufacturer promotes by asking a  
1951 compliance test certificate (Attestation of compliancy) and related test report. This can be considered as  
1952 proof that the product complies with the standards that the utility requires that their smart grid system is  
1953 based on.

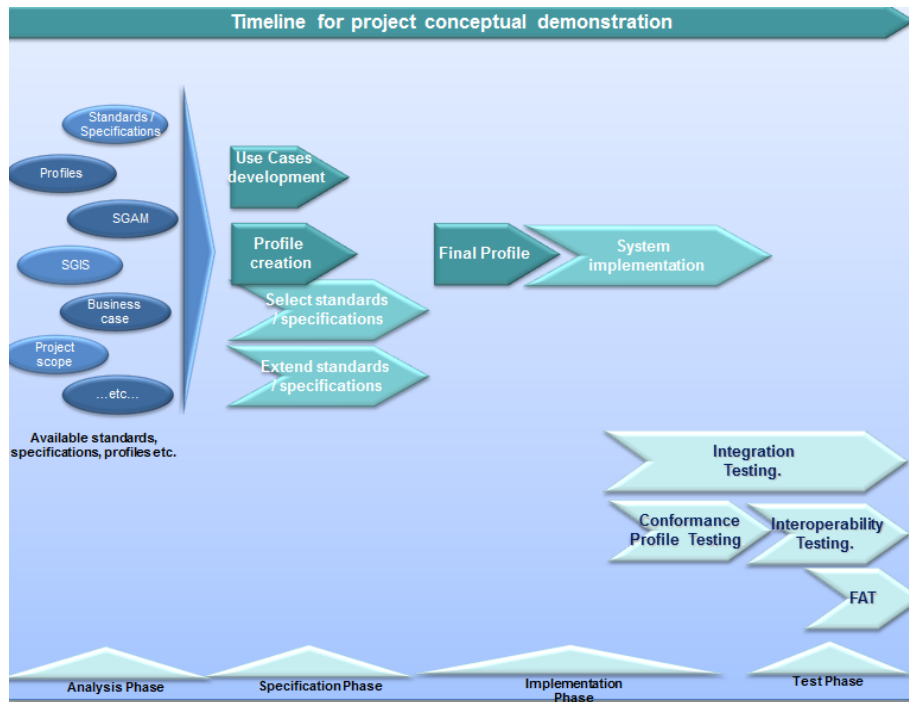

1954  
1955 **Figure 42 timeline for standards development**

1956

1957 As described in this report, compliancy to a standard does not guarantee whatsoever interoperability. To  
1958 realize Interoperability, a utility needs to take additional steps.

1959 To make this next step, a utility should first define the scope of the smart grid project, developing business  
1960 and use cases.

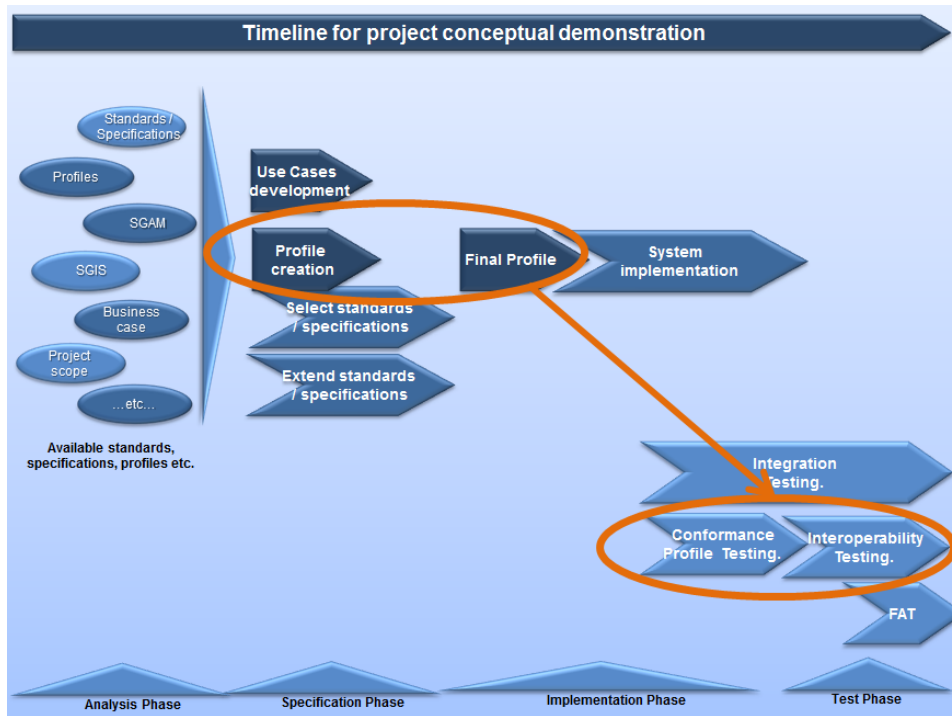

Figure 43 timeline for project conceptual demonstration

After that it is necessary to identify available standards and profiles, also called Basic Application Profiles (BAP). The IOP tool can be considered as an important tool that helps the user in this discovery process. Based on the Use-Case and the identified standards, a profile can be developed. A profile should include references to the selected standards and reduce the amount of open options defined in the standard. The profile should explain in detail how the utility will use the standard and options within the standard. If the standards do not provide facilities for all business requirements as defined in the Use-Case, the profile should describe standard extensions. Standard extensions are extensions of the existing standard, respecting the guidelines to add additional functionality. The final result is a complete profile (the Final profile) that describes up to a detailed level, how the utility will use the standard/specification.

1975  
1976  
1977  
1978  
1979  
1980  
1981  
1982  
1983  
1984  
1985  
1986  
1987  
1988  
1989  
1990  
1991  
1992  
1993  
1994  
1995  
1996  
1997  
1998  
1999  
2000  
2001  
2002  
2003  
2004  
2005  
2006  
2007  
2008  
2009  
2010  
2011  
2012  
2013  
2014

## 12.5 Example: BAPs and BAIOPs in EU FP7 project COTEVOS

COTEVOS is an EU FP7 project that focusses on testing eMobility systems and their Interoperability with Smart Grids (see <http://cotevos.eu/>). COTEVOS is an abbreviation for: Concepts, Capacities and Methods for Testing EV systems and their interoperability within the Smart grids. The COTEVOS project lead by TECNALIA consists further of AIT, ALTRA, DERlab, DTU, ETREL, IWES, RSE, TNO, TUL and ZSDis. One of the work packages in COTEVOS (WP2 Integration and alignment of testing methods with standards) focusses on testing methods and aligning these with standardization activities. This COTEVOS WP2, led by TNO, a Dutch Research Institute, already identified at the beginning of the project in September 2013, that a method based on use cases and resulting in test cases would best serve the goal of testing systems and their Interoperability with Smart Grids (this was also based on the experiences gained by TNO in WP7 of the Green eMotion project (see <http://www.greenemotion-project.eu/>). Another task of WP2 is aligning with standardization activities, as such we came in contact with this M/490 WG Interoperability.

M/490 WGI and COTEVOS WP2 decided to cooperate since COTEVOS and M/490 WGI activities and ideas fit well together (e.g. testing is in scope, applying the V-model, use case based, etc.) and could be of mutual benefit. COTEVOS will, as far as possible in this stage of the project, apply the described WGI methodology, feedback experiences to M/490 WGI, possibly maturing the methodology, and describe initial results. The main initial results and experiences of COTEVOS creating BAPs and BAIOPs are described in this annex, a short summary is also part of the main section of this WGI report.

### 12.5.1 Example of creating BAPs using the Interoperability Process

Because COTEVOS focus is on testing EV systems and their interoperability with Smart Grids the first use case selected is one with Smart Charging. Several use case repositories are available (in WGSP, eMI3 (a kind of eMobility user group, see <http://emi3group.com/>), and Green eMotion), but we took the use case WGSP-1300 Smart (re- / de) charging, since this one is already known and described in M/490. Note that in this version, we do not focus on details, since the main goal is to gain experience with and pipe clean the interoperability methodology itself.

As described in the report in Figure 14: "Process from a Use Case to Interoperability on SGAM layers" the starting point are use cases. The first step is mapping the (business) actors, as described in the use case, on the architecture or create an initial actor architecture. The next step is defining the required functions/services. The third step is mapping these functions and their information flows on the system from the actors and other physical components. These 3 steps are shown in Figure 44 below.

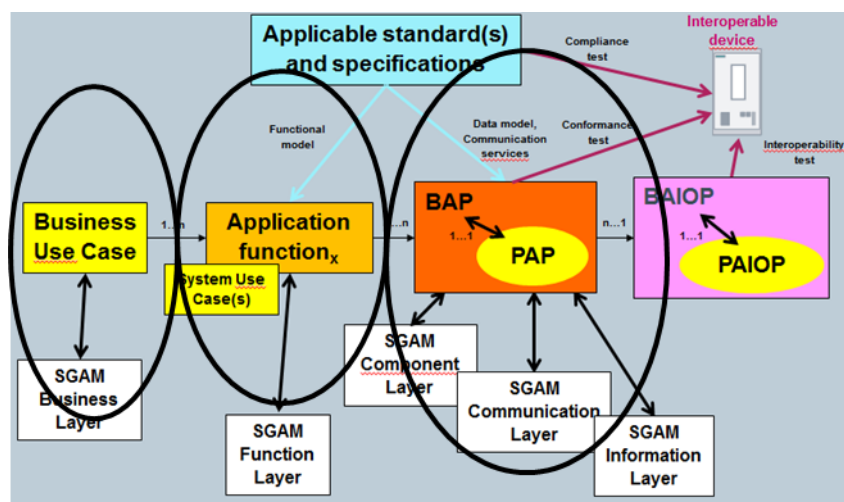

Figure 44 Steps in the Process from Use Case to Interoperability

#### 12.5.1.1 Mapping the actors of the smart charging use case on an actor architecture

The first step is mapping the actors of the system, as described in the use case, on an actor architecture. Since in COTEVOS already a Reference Architecture has been developed this mapping on SGAM business layer is straightforward and easy also since the use case clearly defines actors. The actor names are different, so the use case actor names are mapped on the COTEVOS actor names. This first step is shown in Figure 45.

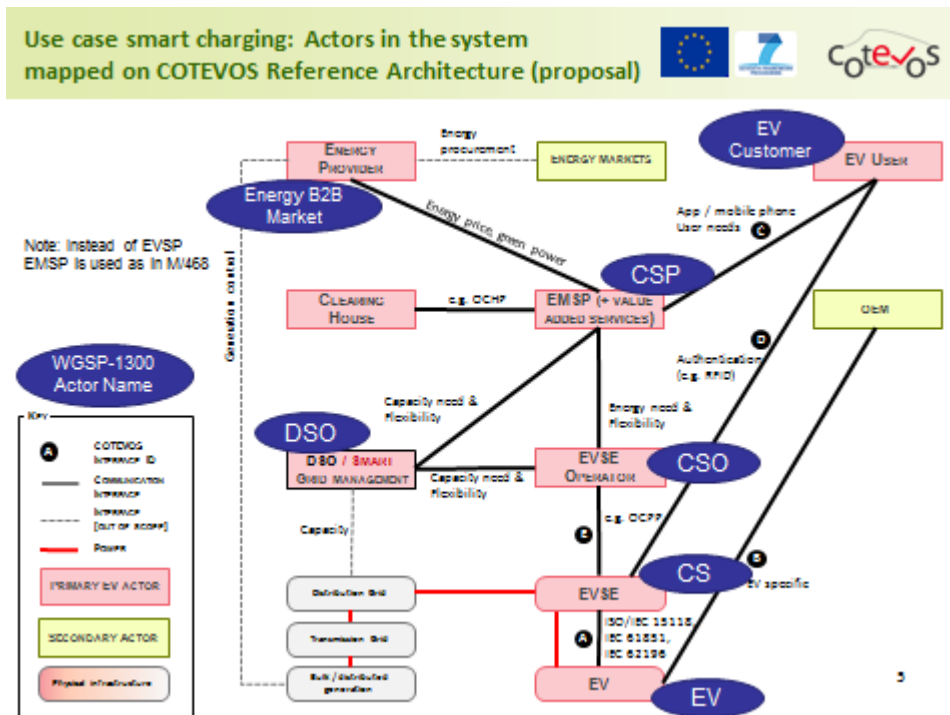

Figure 45 Mapping of the use case actors on the COTEVOS reference architecture

So, if the use case clearly defines actors and a complete architecture is available, this first step is straightforward.

### 12.5.1.2 Defining the required functions/services from the use case

The next step is defining the required functions based on the step by step analysis already described in the use case. To identify the application functions from the use case is quite some work, but not a complex task. The results can be found in Table 4 below.

Actors	Function
EV	EV Information collection
EV User	EV user preferences collection
EMSP	Contract Check
EMSP	Technical viability check
Energy provider	B2B energy price and availability check
EMSP	EVSE identification
EMSP	Customer-optimized charge plan calculation
DSO	Capacity negotiation & clearance
EVSE operator	Charge plan execution
EMSP	Customer feedback

Table 4 Required functions from the use case with the initiating actor

As described in the process in Figure 14 in this stage already some possible standards can be identified when they relate to the information exchanged by the functions. Using the IOP tool gives us standards like IEC 61980 (Electric vehicle inductive charging system), IEC 61851 (Electric vehicles conductive charging system), and ISO/IEC 15118 (Vehicle to grid communication interface). For conductive charging the last two standards are important and for EV Information collection mainly the ISO/IEC 15118.



2032

2033 **12.5.1.3 Mapping the use case functions and their information flows on the system**

2034 The next step is mapping these functions and their information flows on the systems from the actors and  
2035 other physical components. First the information flows needs to be made clear, see the Figure 46 below.

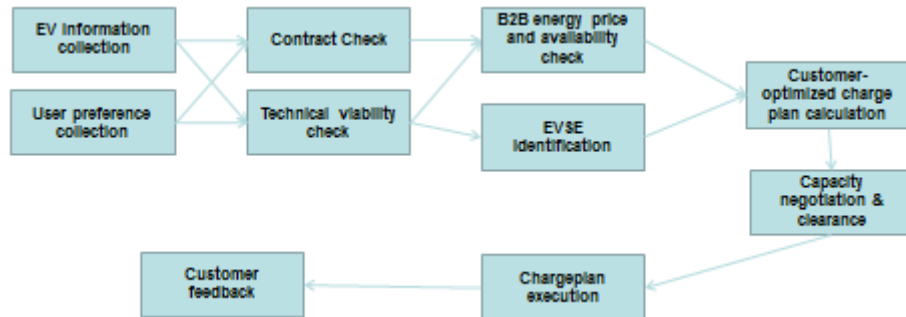

2036

2037 **Figure 46 Information flows between the different function**

2038

2039 The mapping of functions and flows on the systems from the actors and other physical components results in  
2040 the Figure 47 below.

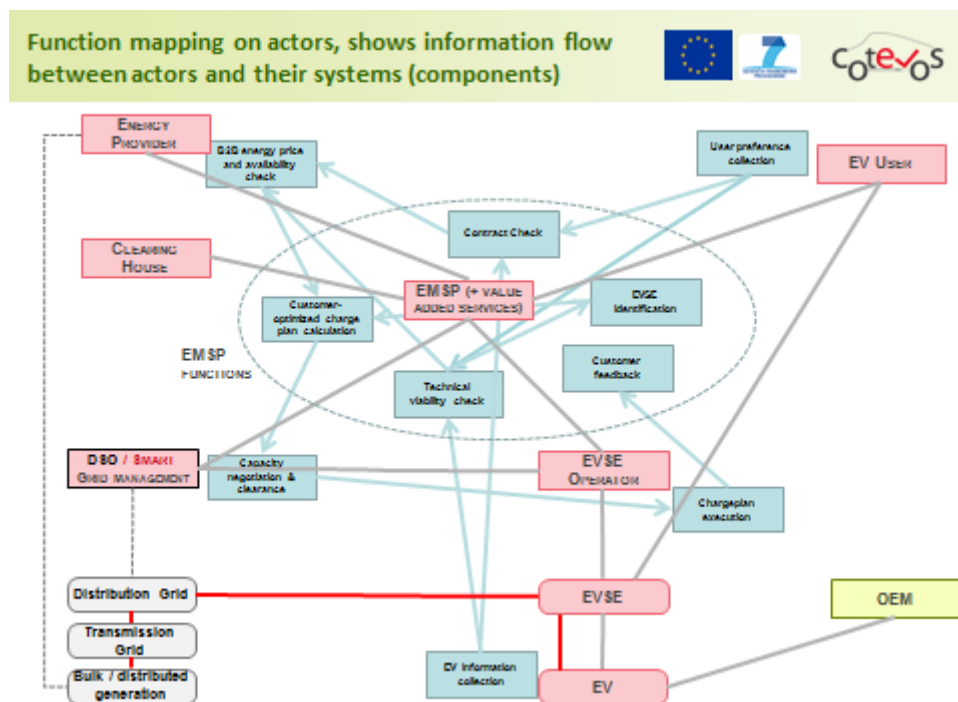

2041

2042 **Figure 47 Function mapping on actors with information flows**

2043

2044 Now the required information flows and interfaces between components are clear, information flows can be  
2045 combined when they are exchanged between same components or systems in the architecture. This leads to  
2046 5 main communication interfaces required for the Smart Charging use case as made visible in the Figure 48  
2047 below. Note for simplicity we removed the EV user interaction since this is often a service provider dedicated  
2048 interface and therefore does not need a BAP now. Further we rerouted the charge plan execution flow via de  
2049 EMSP.

Use case smart charging, mapped on COTEVOS Reference Architecture (preliminary)

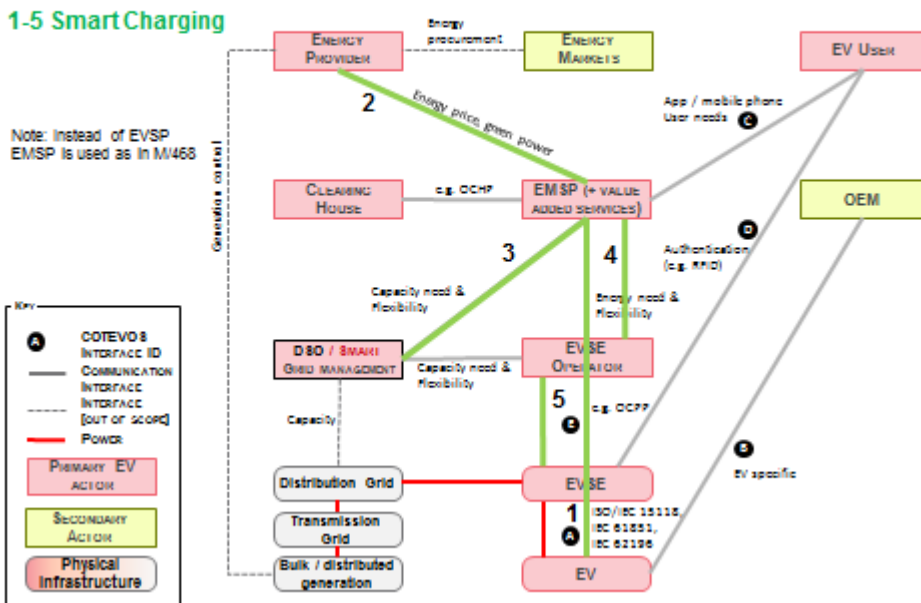

Figure 48 Use case smart charging in COTEVOS Reference Architecture

2050  
2051

2052  
2053

### 12.5.1.4 Creating the first BAPs

2054  
2055  
2056  
2057  
2058  
2059

Now we have enough material to start creating one or more BAPs. We can create one BAP out of this use case, but that would lead to as many BAPs as use cases, also any alternative in interfaces lead to a complete new BAP (since there cannot be alternatives/options in BAPs itself!). Also as defined BAPs can be used as building blocks (“Combinations of different BAPs are used in real projects as building blocks”), therefore (in this case) the best option is to create a BAP per combined information flow. This first use case leads than to 5 different BAPs.

2060  
2061  
2062  
2063

We need to discuss on information flow 1 between EV and EMSP. This can be a direct link (e.g. via a 3G mobile connection), routed via the OEM (e.g. to the OEM via a 3G mobile connection, and an internet based direct connection between OEM and EMSP) or via the EVSE (e.g. ISO-IEC 15118-2 (PWM) + OCPP V2.0, or IEC 61851 + OCPP V1.5, and the link between EVSE Operator and EMSP).

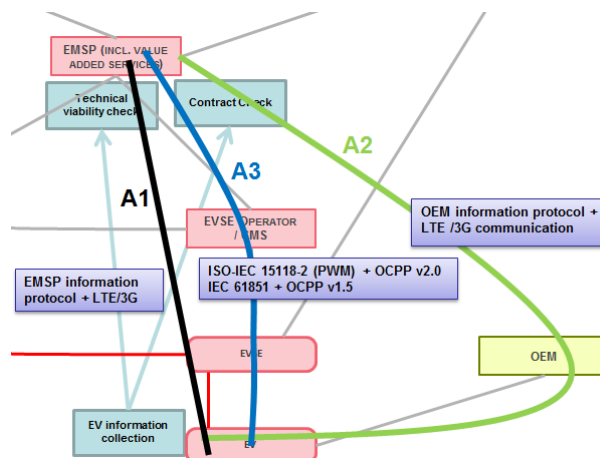

Figure 49 Information flow with multiple routing options

2064  
2065  
2066

2067  
2068  
2069

So for this BAP we have 3 options. BAPs itself do not have options, but we can choose here between 3 different BAPs (labeled as A1, A2, and A3). Suppose an alternative for OCPP would be the S-protocol (not existing, a nickname) this will be labeled as BAP A4.

2070  
2071  
2072

This picture above led in COTEVOS and WGI to the discussion if an information flow with intermediate routing links is one BAP or has one BAP per link/interface. We approached this discussion with an example EVSE, see Figure 50 below.

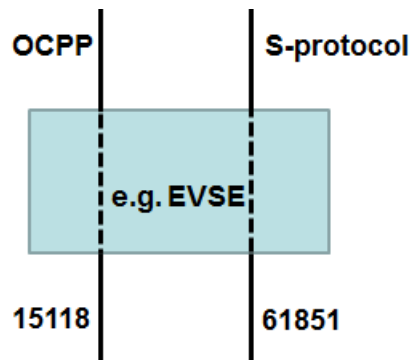

2073  
2074  
2075

**Figure 50 Example EVSE for discussion on multiple routing information flows**

2076  
2077  
2078  
2079  
2080  
2081  
2082  
2083  
2084  
2085

This EVSE is able to transfer messages received from 15118 onto OCPP and messages received from IEC61851 onto S-protocol but no other combinations. Although the block below talks 4 protocols, it cannot do the BAP 61851+OCPP. When we would create 4 single link BAPs this block would be compatible with BAP 61851 and BAP OCPP, but making not clear that IEC61851+OCPP is not possible, so leading to interoperability issues. For this reason we came to the conclusion that an information flow with intermediate routing links should be covered with one BAP. Also timing and conversion issues are covered with BAPs like IEC61851+OCPP.

With this we can conclude that from the possible BAPs: IEC15118+S-protocol, IEC15118+OCPP, IEC61851+S-protocol, IEC61851+OCPP, the example above is only interoperable with BAP IEC15118+OCPP and IEC61851+S-protocol.

2086  
2087  
2088  
2089  
2090  
2091

Remaining from the use case are still 4 information flows, these can now easily be mapped on a BAP:

- Flow 2, we call it BAP B, could be any electricity market protocol, nicknamed here eMarket
- Flow 3, we call it BAP C, should be a smart grid protocol, as example Power Matcher
- Flow 4, we call it BAP D, is probably a derivative of OCPP, so nicknamed here OCPP-alike
- Flow 5, we call it BAP E, but since we already mentioned OCPP and the S-protocol we have here BAP E1 and BAP E2.

2092

Summarized this leads to the following different BAPs as mentioned in the Table 5 below.

Use Case	From	To	Type of information	BAP	EMSP-3G	eMarket	PowerMatcher	OCPP-alike	OCPP	S-protocol	15118	OEM Backend	OEM 3G
Smart Charging	EV	EMSP	EV info etc.	A1	X								
Smart Charging	EV	via OEM	EV info etc.	A2								X	X
Smart Charging	EV	via EVSE (with OCPP)	EV info etc.	A3			X	X		X			
Smart Charging	EV	via EVSE (with S-prot)	EV info etc.	A4			X	X	X				
Smart Charging	EP	EMSP	Energy price info	B	X								
Smart Charging	DSO	EMSP	Grid capacity	C		X							
Smart Charging	EMSP	EVSEop	Charge Plan	D			X						
Smart Charging	EVSEop	EVSE	Charge Plan	E1				X					
Smart Charging	EVSEop	EVSE	Charge Plan	E2					X				

2093  
2094  
2095

**Table 5 List of BAPs required for the first eMobility Smart Charging use case**

2096

### 12.5.1.5 Creating additional BAPs from the second use case Authentication and Roaming

2097  
2098  
2099  
2100  
2101

A second use case on Authentication and Roaming has been worked out in the same way. Stand-alone this use case would also lead to 5 BAPs, but three of them can be combined with one of the BAPs of the previous use case since the interface used is the same, see Figure 51 below. New is information flow 6, which could for example be an RFID card interface (BAP F), and information flow 8, which could for example be OCHP (BAP G).

Use case smart charging and authorization & roaming, mapped on COTEVOS Reference Architecture (preliminary)



1-5 Smart Charging  
6-10 Authentication

Note: Instead of EVSP EMSP is used as in M468

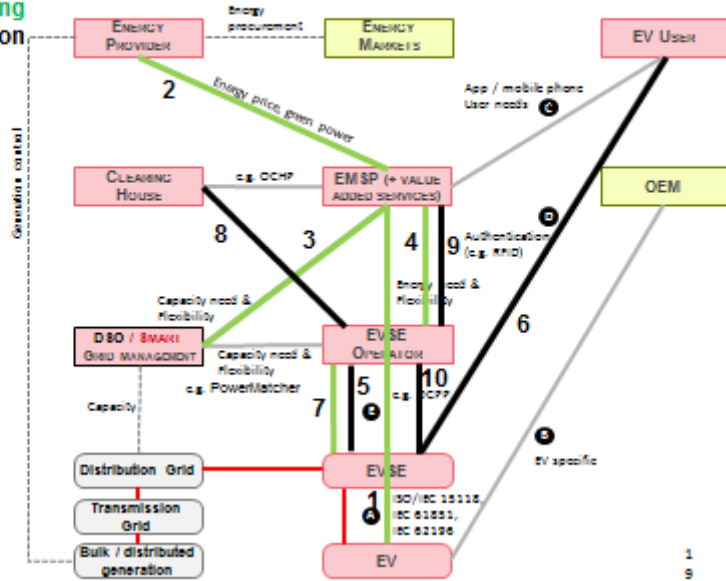
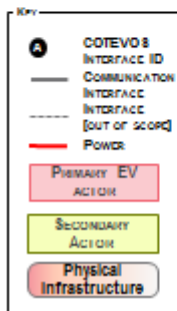

Figure 51 Two eMobility use cases in the COTEVOS Reference Architecture

So in total with 7 main BAPs we can cover these 2 use cases (see BAP A to G in the Table 6 below). The column 'type of information' provides already a starting point for the mandatory elements of using these standards/specifications.

Use Case	From	To	Type of information	BAP	EMSP-3G eMarket	PowerMatcher	OCPP-alka	OCPP	S-protocol 15118	OEM Backend	OEM 3G	RFID	OCPP
Smart Charging	EV	EMSP	EV info etc.	A1	X								
Smart Charging	EV	via OEM	EV info etc.	A2						X	X		
Smart Charging	EV	via EVSE (with OCPP)	EV info etc.	A3			X	X	X				
Smart Charging	EV	via EVSE (with S-prot)	EV info etc.	A4			X	X	X				
Smart Charging	EP	EMSP	Energy price info	B	X								
Smart Charging	DSO	EMSP	Grid capacity	C		X							
Authentication, Roaming	EVSEop	EMSP	info	D			X						
Smart Charging	EMSP	EVSEop	Charge Plan	D			X						
Authentication, Roaming	EVSE	EVSEop	id	E1			X						
Authentication, Roaming	EVSEop	EVSE	OK	E1			X						
Smart Charging	EVSEop	EVSE	Charge Plan	E1			X						
Authentication, Roaming	EVSE	EVSEop	id	E2				X					
Authentication, Roaming	EVSEop	EVSE	OK	E2				X					
Smart Charging	EVSEop	EVSE	Charge Plan	E2				X					
Authentication, Roaming	EV User	EVSE	id	F							X		
Authentication, Roaming	EVSEop	CH	id, OK	G									X

Table 6 List of BAPs required for the two selected eMobility use cases

12.5.1.6 Finalizing the eMobility set of BAPs from remaining use cases

With the remaining use cases, and also the alternatives mentioned in these use cases, we finalized (partly automated) the eMobility set of BAPs that now extends from 7 to 16 main BAPs. Some information links are not often used so results in a 'smaller' BAP with less information content. Some other links are more frequently used and results in a BAP which lists a lot of information elements, since these are now automatically derived from the use cases.

We have included the information from the following use cases:

- WGSP-1100 Uncontrolled charging.

- 2119 • WGSP-1200 Charging with demand response.
- 2120 • WGSP-1300 Smart (re- / de) charging.
- 2121 • WGSP-1400 Ensuring interoperability and settlement.
- 2122 • WGSP-1500 Manage charge infrastructure.

2123 These use cases lead to the following BAPs in the list bullet below. We listed them with the interface,  
2124 protocol choices (then it will be a different (version of the) BAP) and main information elements exchanged.  
2125 We made 5 BAPs bold, these are the most used in the different use cases. We copied information elements  
2126 from the use cases.

- 2127 • **BAP A:** Interface between EV-EMSP  
2128 Choose between (BAP A1 A2 A3 A4) 3G to EMSP, 3G via OEM Backend, or via ISO/IEC 15118 etc.  
2129 Information element examples: EV charging capabilities, Battery status, State of Charge, EV type  
2130 identification.
- 2131 • **BAP B:** Interface between EMSP-EP  
2132 Choose between: Current electricity Market protocols, ...  
2133 Information element examples: Supply availability (Energy quantity (kWh), Energy type (RES), Power  
2134 quantity (kW), ...), Tariff.
- 2135 • **BAP C:** Interface between EMSP-DSO  
2136 Choose a Smart Grid protocol (e.g. PowerMatcher) or specify one  
2137 Information element examples: Customer/EMSP/DSO-optimized charging request,  
2138 Calculated customer/EMSP-optimized charge plan, EVSE identification, Acknowledgement/OK, Charge  
2139 request information for offerings, EVSE information,  
2140 Available capacity in network segment, Other EV identifiers of same EMSP in network segment, ...
- 2141 • **BAP D:** Interface between EMSP-EVSE  
2142 Choose likely a kind of OCPP or derivative  
2143 Information element examples: Charging Details Records (power, time, etc.), Charge request information  
2144 for offerings, EVSE identification.
- 2145 • **BAP E:** Interface between EVSE-EVSE  
2146 Choose between OCPP (E1), or some alternatives  
2147 Information element examples: Release EVSE, Access to EVSE, No Access to EVSE, No heartbeat,  
2148 wrong data, Reset (Hard/Soft), Update, who is charging, amount of energy, which EVSE, ...
- 2149 • **BAP F:** Interface between EVUser-EVSE  
2150 Choose e.g. Smart Card with RFID  
2151 Information element examples: Charge Card number, Charge Station ID, date, time, Plugout signal, ...
- 2152 • **BAP G:** Interface between EVSE-CH  
2153 Choose between Clearing House protocols like OCHP.  
2154 Information element examples: Charge Card number, Charge Station ID, Transaction ID, time, date, ...
- 2155 • **BAP H:** Interface between EMSP-EMSP-Other  
2156 Choose a special EMSP agreed interface.  
2157 Information element examples: Proposal for exchanging / buying charging capacity in specific network  
2158 segment.
- 2159 • **BAP I:** Interface between EV-EVSE  
2160 Choose from and between (can be a combination!): IEC 61851, ISO-IEC 15118, IEC 62196.  
2161 Information element examples: electrical mode 3 handshake, ...
- 2162 • **BAP J:** Interface between EVUser-EMSP  
2163 Choose a device e.g. Smart Phone, can be EMSP specific as the user has a 'flexible' interface  
2164 Information element examples: Offerings, OK, Proposal for an alternative for original charge request,  
2165 Settlement data (power, time, tariff etc.), Time of departure, Range / energy demand, Energy type (RES),  
2166 Budget, Customer identification information, Transaction data, payment, etc.
- 2167 • **BAP K:** Interface between DSO-EVSE  
2168 Choose between a kind of smart grid protocol, likely only that also includes a mode for grid emergency  
2169 handling.  
2170 Information element examples: Approved charge plan, EVSE identification.



- 2171
- BAP L: Interface between CH-EMSP
- 2172 Choose between Clearing House protocols like OCHP.
- 2173 Information element examples: Transaction ID, time, date, ...
- 2174
- BAP M: Interface between EVSE-EVUser
- 2175 Choose between different User Interfaces to EVSE, can be partly EVSE specific as the user has a
- 2176 'flexible' interface.
- 2177 Information element examples: Transaction ID, time, date, ...
- 2178
- BAP N: Interface between EVSEO-CIO (ChargeSpot Infrastructure Operator)
- 2179 Choose between, still open.
- 2180 Information element examples: Location, Type of Malfunction, asset assignment
- 2181
- BAP O: Interface between EV-EVSE-EVSEO
- 2182 This includes plug-out events communication to EVSEO.
- 2183 Information element examples: Information about charging.
- 2184
- BAP P: Interface between EVUser-EV
- 2185 Choose between different User Interfaces to EVSE, can be partly EVSE specific as the user has a flexible
- 2186 interface.
- 2187 Information element examples: Charge-Plan (schedule), End charge signal.

2188 Overseeing the list above it becomes very clear that a lot of specification work is still to be done for a

2189 complete set of well described BAPs. Since a BAP is defined as a "selection and interpretation of relevant

2190 parts of the applicable standards and specifications" it means that after this step a study of the different

2191 standards needs to be done, and to be described and specifies what the different BAPs will use of these

2192 standards (or specifications).

2193

#### 2194 **12.5.2 Experience and example of creating BAIOPs for testing using the Interoperability Process**

2195 To assist interoperability of BAPs they can be extended to interoperability testing. The extended BAP is

2196 referred to as Basic Application Interoperability Profile (BAIOP). For interoperability testing (in the two use

2197 case example) in the case for Authentication, Roaming and Smart Charging the extensions are required on:

- Device configuration: e.g. EVs under test should have smart charging enabled.
- Test configuration: e.g. a Smart Grid with 2 EVs (EV1 and EV2) charging at an EVSE both at same line/feeder on the grid.
- BAP related test cases: e. g. a test case where while EV1 is charging, the charge plan request of EV2 leads to a modified charge plan for both EVs.
- Communication infrastructure (topology).

2204 A possible BAIOP1 for Authentication, Roaming and Smart Charging consists out of the BAPs A3 B C D E1

2205 F and G (see the table below ), which means we have selected and described what will be used from the

2206 following standards/specifications: ISO/IEC 15118, eMarket, Power Matcher, OCPP-alike, OCPP, RFID, and

2207 OCHP.

2208 An alternative specification could have been BAIOP2 with BAPs A1 B C D E2 F G (see Table 7below), which

2209 means we have selected and described what will be used from the following standards/specifications: 3G

2210 mobile to EMSP, ISO/IEC 15118, eMarket, Power Matcher, OCPP-alike, S-protocol, RFID, and OCHP.



Use Case	From	To	Type of information	BAP	EMSP-3G eMarket	PowerMatcher	OCPP-ai/ke	OCPP	S-protocol 15118	OEM Backend	OCEN 3G	RHD	OCHP	BAIOP	BAIOP
Smart Charging	EV	EMSP	EV info etc.	A1	X										BAIOP2
Smart Charging	EV	via OEM	EV info etc.	A2						X	X				
Smart Charging	EV	via EVSE (with OCPP)	EV info etc.	A3			X	X	X					BAIOP1	
Smart Charging	EV	via EVSE (with S-protocol)	EV info etc.	A4			X	X	X						
Smart Charging	EP	EMSP	Energy price info	B	X									BAIOP1	BAIOP2
Smart Charging	DSO	EMSP	Grid capacity	C		X								BAIOP1	BAIOP2
Authentication, Roaming	EVSEop	EMSP	info	D			X							BAIOP1	BAIOP2
Smart Charging	EMSP	EVSEop	Charge Plan	D			X							BAIOP1	BAIOP2
Authentication, Roaming	EVSE	EVSEop	id	E1			X							BAIOP1	
Authentication, Roaming	EVSEop	EVSE	OK	E1			X							BAIOP1	
Smart Charging	EVSEop	EVSE	Charge Plan	E1			X							BAIOP1	
Authentication, Roaming	EVSE	EVSEop	id	E2				X							BAIOP2
Authentication, Roaming	EVSEop	EVSE	OK	E2				X							BAIOP2
Smart Charging	EVSEop	EVSE	Charge Plan	E2				X							BAIOP2
Authentication, Roaming	EV User	EVSE	id	F							X			BAIOP1	BAIOP2
Authentication, Roaming	EVSEop	CH	id, OK	G								X		BAIOP1	BAIOP2

**Table 7 BAIOPs created with list of BAPs for the two selected eMobility use cases**

A BAIOP includes test cases. If the BAIOP with the test cases are executed by another party one a system with the same BAPs the results on system level should be the same. Of course data on the communication layer can be different (other id of user, other id of EVSE, other time stamps etc.), but on higher level layer (information layer or above) it should lead to the same system results like: EV1 get assigned the requested charge plan, when EV2 is connected and the requested grid capacity is too low, as well the charge plan of EV2 and EV1 are renegotiated to fit with the available capacity. If after that the available capacity is increased it should again lead to increased charging powers for at least one of the EVs.

Above we implicitly assumed we need to test the whole system. This is normally not the case, than for the Devices Under Test less BAPs are needed and also the BAIOP will be simpler. Take a simple example where a Clearing House needs to be tested. This only required a BAIOP covering BAP G and BAP L, the interfaces between EVSE-CH and CH-EMSP. But the test system requires a system simulator or stimuli that can generate the information elements required for this system test. So system scope and system behavior remains necessary for interoperability tests.

In COTEVOS we have not completed development of full test cases. So we also do not have BAP related test cases ready for this document that are required for the BAIOP.

It is expected that the BAIOP set of test cases will be built on several use case functions that together cover the documented use cases (see also ISO/IEC 15118 documentation for use case functions). Use case functions can be like:

- Initiate EVSE/system.
- Start charging session.
- Identification and Authorization.
- Smart charge scheduling.
- Charge execution and control.
- Charge session information distribution.
- End charging session.

### 12.5.3 First observations and conclusion from creating BAPs and BAIOPS

If a use case clearly defines actors and a (actor) architecture is available, the first step of mapping a use case on the SGAM business layer is straightforward.

Identifying the application functions from the use case is more work, but not a complex task. This step also ensures the use case is checked on consistency (which function at which actor uses the output of a previous function and actor). It also prevents deciding too earlier on a certain interface or implementation, since in use cases often already these kind of assumptions are already made implicitly.

If the architecture is available (with the systems from the actors and other physical components) the functions can be mapped on that. That enables selection and choosing the different information and communication standards and specifications.

2250  
2251  
2252  
2253

Physical components have an important impact on the communication layer choices (e.g. EVSE and EV), since there are several physical limitations that often do not or less exist on higher level layers. This is also the reason why on this physical layer more standards are available or in development than on higher level layers.

2254  
2255  
2256

We also came to the conclusion that an information flow with intermediate routing links is one BAP, so one BAP can cover multiple protocols and standards. Also timing and conversion issues are covered better with this approach, ensuring interoperability much better.

2257  
2258  
2259  
2260  
2261  
2262

A final observation, the process of creating BAPs and BAIOPs also helps to verify the consistency of use cases and related documentation. Combining the information elements in BAPs and interfaces makes clear where use cases are not consistent or contain mistakes. So BAPs and BAIOP helps the development process to achieve interoperability, but what exactly needs to be put in a BAP or BAIOP specification needs to be further explored in this or other working group or projects, hopefully resulting in a recommendation and template for a BAP as well a BAIOP.

2263

2264

2265 **12.6 Example: Standards & specification selection for DER EMS and VPP system**

2266 DER EMS and VPP systems refer to the operation and enterprise management system and all the elements  
2267 needed to control the generation process of a single DER entity or a set of DERs combined to a VPP. The  
2268 DER EMS/VPP can act as a:

- 2269 • technical VPP (tVPP) interacting directly with the DSO or as a
- 2270 • commercial VPP (cVPP) interacting with the energy market.

2271 The system provides information on the generation capabilities of the DER/VPP and the expected generation  
2272 (forecast). It controls the actual generation and storage including VAR regulation and frequency support  
2273 based on requests and schedules received from the market or DSO.

2274 The DER EMS/VPP System interacts with the DER operation system, weather forecast system (wind farms  
2275 and PV), related DSO systems (power quality control, DMS/SCADA...) (tVPP) and the market (cVPP).

2276 The IOP Tool helps to identify relevant standards by filtering for layers, systems and zones. This procedure  
2277 is shown below for the DER EMS and VPP system.

2278 In the pictures below some columns of the IOP Tool were hidden to improve readability. They contain no  
2279 further filtering.

2280

2281 **12.6.1 Component layer**

2282 The component zone architecture covers all zones.

- 2283 • The Process zone with the DERs, inverters and related sensors and actors.
- 2284 • The Field zone with the DER unit controller The Station zone with the DER plant controller.
- 2285 • The Operation zone with the tVPP/EMS which may interact with the DSOs DMS in case of tVPP.
- 2286 • The Enterprise zone with the cVPP which interacts with the market platform or directly with an energy  
2287 retailer.

2288 Figure 52 shows the component layer on the smart grid plane.

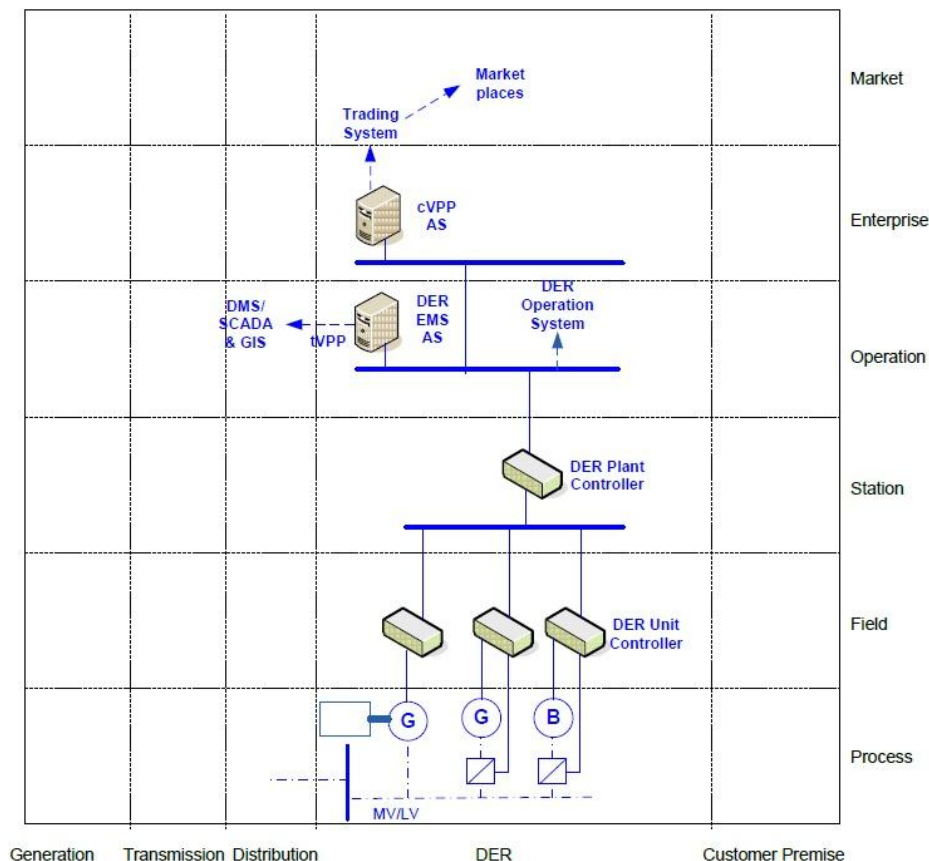

2289

2290

**Figure 52 DER EMS and VPP system - Component layer**

2291  
2292  
2293

In the component layer the components and arrangement are represented in very generic ways. All standards listed in the *First Set of Standards report* for the component layer are relevant to process zone. Figure 53 shows the results of filtering the IOP Tool as follows:

2294  
2295  
2296

- Layer: *Component*.
- System: *DER EMS and VPP systems* (in domain *DER*).
- Zone: *Process*.

	A	B	C	E	AA	AB	BA	BH	BI	BJ	BK	BL	BM	BN	BO	
1				Layer	Domain			Testing								
2				Component	DER			Zone								
3	Standardization organization	Standards	Title		General	DER management systems	Process	Electrical	Mechanical	System	Conformance	Interoperability	Acceptance	N/A	Type / Routine Test	
68	CEN / CENELEC	EN 61400-1	Wind turbines - Part 1: Design requirements	X	X	X	X							X		
69	CEN / CENELEC	EN 61400-2	Wind turbines - Part 2: Design requirements for small wind turbines	X	X	X	X	X	X	X					T	
159	CEN / CENELEC	EN 50438	Requirements for the connection of micro-generators in parallel with public low-voltage distribution networks	X	X	X	X							X		
168	CEN / CENELEC	CLC 50549-1	Requirements for the connection of generators above 16 A per phase - Part 1: Connection of the LV distribution	X	X	X	X							X		
169	CEN / CENELEC	CLC 50549-2	Requirements for the connection of generators above 16 A per phase - Part 2: Connection to the MV distribution system	X	X	X	X							X		
170	CEN / CENELEC	CLC 50549-3	Conformance testing for connection of DER systems to LV and MV network	X	X	X	X							X		
333	IEC	IEC 62600 series	Marine energy	X	X	X	X							X		
334	IEC	IEC 62689 (all parts)	Current and voltage sensors or detectors, to be used for fault passage indication purposes	X	X	X	X							X		

2297  
2298  
2299  
2300

Figure 53 IOP Tool - Layer Component, Domain DER, Zone Process

Table 8 gives an overview of the identified standards and relevant technical bodies.

Standard	Title	Technical Body
EN 61400-1	Wind turbines - Part 1: Design requirements	CLC/TC 88
EN 61400-2	Wind turbines - Part 2: Design requirements for small wind turbines	CLC/TC 88
prEN 50438	Requirements for micro-generating plants to be connected in parallel with public low-voltage distribution networks	CLC/TC 8X
prTS 50549-1	Requirements for the connection of generators above 16 A per phase - Part 1: Connection to the LV distribution system	CLC/TC 8X
prTS 50549-2	Requirements for the connection of generators above 16 A per phase - Part 2: Connection to the MV distribution system	CLC/TC 8X
CLC 50549-3	Conformance testing for connection of DER systems to LV and MV network	CLC/TC 8X

IEC 62600 series	Marine energy	IEC/TC 114
IEC 62689 (all parts)	Current and voltage sensors or detectors, to be used for fault passage indication purposes	IEC/TC 38

**Table 8 Standards - Layer Component, Domain DER, Zone Process**

**12.6.2 Communication layer**

Figure 54 shows the communication layer on the smart grid plane, including the standards listed in the *First Set of Standards report*. The blue bubbles show the type of network to consider:

- (C) Field Area Network.
- (E) Intra-substation network.
- (G) Intra-Control Centre / Intra-Data Centre network.
- (H) Enterprise Network.
- (I) Balancing Network.
- (L) Wide and Metropolitan Area Network.
- (M) Industrial Fieldbus Area Network.

For more details refer to *Set of Standards report (SG-CG/G)*.

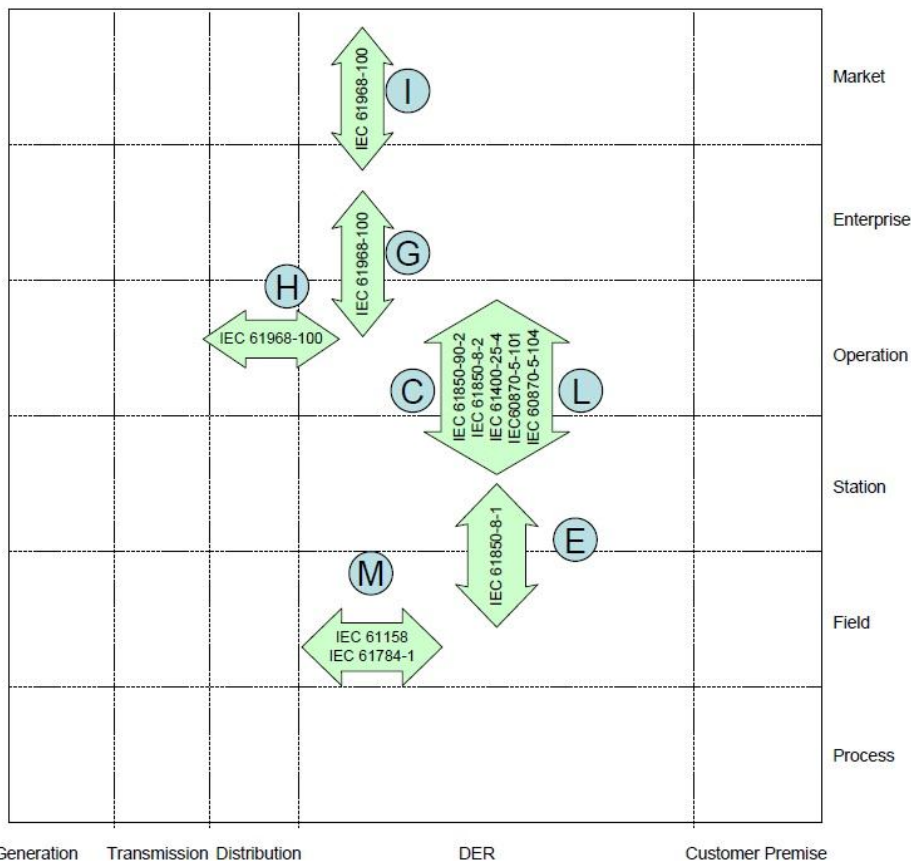

**Figure 54 DER EMS and VPP system - Communication layer**

From Figure 54 it is obvious that except for the link to *DMS SCADA and GIS* in zone *Operation* only domain *DER* is relevant. For each link a filtering procedure to identify relevant standards is described below.

The communication path at the bottom (M) appears between components in zone *Field*. With this the following filtering of the IOP Tool is necessary:

- Layer: *Communication*.
- System: *DER EMS and VPP systems* (in domain *DER*).
- Zone: *Field*.



2324  
2325

Figure 55 shows the results of filtering the IOP Tool in this way. Table 9 gives an overview of the identified standards and relevant technical bodies.

Standard	Standards	Title	Communication	Domain			Field	Testing										Type / Routine Test
				General	DER management systems	Zone		Electrical	Mechanical	System	Conformance	Interoperability	Acceptance	N/A				
CEN / CENELEC 38	EN 60870-5-101	Telecontrol equipment and systems - Part 5-101: Transmission protocols; Companion standard for basic telecontrol tasks	X	X	X	X											X	
CEN / CENELEC 41	EN 60870-5-104	Telecontrol equipment and systems - Part 5-104: Transmission protocols - Network access for IEC 60870-5-101 using standard transport profiles	X	X	X	X											X	
CEN / CENELEC 61	EN 61158	Industrial communication networks - Fieldbus specifications	X	X	X	X											X	
CEN / CENELEC 87	EN 61850-8-1	Communication networks and systems for power utility automation - Part 8-1: Specific communication service mapping (SCSM); Mappings to MMS (ISO 9506-1 and ISO 9506-2) and to	X	X	X	X						X						
IEC 269	IEC 61784-1	Industrial communication networks - Profiles - Part 1: Fieldbus profiles	X	X	X	X											X	
IEC 276	IEC 61850-8-2	Communication networks and systems for power utility automation - Part 8-2: Specific communication service mapping (SCSM) - Mappings to web-	X	X	X	X											X	
IEC 284	IEC 61850-90-2	Use of IEC 61850 for the communication between substations and control centres	X	X	X	X											X	

2326  
2327  
2328

Figure 55 IOP Tool - Layer Communication, Domain DER, Zone Field

Standard	Title	Technical Body
EN 60870-5-101	Telecontrol equipment and systems - Part 5-101: Transmission protocols; Companion standard for basic telecontrol tasks	IEC/TC 57
EN 60870-5-104	Telecontrol equipment and systems - Part 5-104: Transmission protocols - Network access for IEC 60870-5-101 using standard transport profiles	IEC/TC 57
EN 61158	Industrial communication networks - Fieldbus specifications	IEC/SC 65C
EN 61850-8-1	Communication networks and systems for power utility automation - Part 8-1: Specific communication service mapping (SCSM); Mappings to MMS (ISO 9506-1 and ISO 9506-2) and to ISO/IEC 8802-3	IEC/TC 57
IEC 61784-1	Industrial communication networks - Profiles - Part 1: Fieldbus profiles	IEC/SC 65C
IEC 61850-8-2	Specific communication service mapping (SCSM) - Mappings to web-services	IEC/TC 57
IEC 61850-90-2	Use of IEC 61850 for the communication between substations and control centers	IEC/TC 57

2329

Table 9 Standards - Layer Communication, Domain DER, Zone Field

2330

The next communication path (E) appears between components within zones *Field* and *Station*. With this the following filtering of the IOP Tool is necessary:

2331  
2332  
2333  
2334

- Layer: *Communication*
- System: *DER EMS and VPP systems (in domain DER)*



2335  
2336  
2337

- Zones: *Field* AND *Station*

Figure 56 shows the results of filtering the IOP Tool for zones *Field* and *Station* on layer *Communication*. Table 10 gives an overview of the identified standards and relevant technical bodies.

Layer	Standardization organization	Standards	Title	Domain		Zone		Testing							Type / Routine Test		
				Communication	DER	Field	Station	Electrical	Mechanical	System	Conformance	Interoperability	Acceptance	N/A			
																General	DER management systems
38	CEN / CENELEC	EN 60870-5-101	Telecontrol equipment and systems - Part 5-101: Transmission protocols; Companion standard for basic telecontrol tasks	X	X	X	X	X									X
41	CEN / CENELEC	EN 60870-5-104	Telecontrol equipment and systems - Part 5-104: Transmission protocols - Network access for IEC 60870-5-101 using standard transport profiles	X	X	X	X	X									X
87	CEN / CENELEC	EN 61850-8-1	Communication networks and systems for power utility automation - Part 8-1: Specific communication service mapping (SCSM); Mappings to MMS (ISO 9506-1 and ISO 9506-2) and to	X	X	X	X	X				X					
276	IEC	IEC 61850-8-2	Communication networks and systems for power utility automation - Part 8-2: Specific communication service mapping (SCSM) - Mappings to web-	X	X	X	X	X									X
284	IEC	IEC 61850-90-2	Use of IEC 61850 for the communication between substations and control centres	X	X	X	X	X									X

2338  
2339  
2340

Figure 56 IOP Tool - Layer Communication, Domain DER, Zones Field and Station

Standard	Title	Technical Body
EN 60870-5-101	Telecontrol equipment and systems - Part 5-101: Transmission protocols; Companion standard for basic telecontrol tasks	IEC/TC 57
EN 60870-5-104	Telecontrol equipment and systems - Part 5-104: Transmission protocols - Network access for IEC 60870-5-101 using standard transport profiles	IEC/TC 57
EN 61850-8-1	Communication networks and systems for power utility automation - Part 8-1: Specific communication service mapping (SCSM); Mappings to MMS (ISO 9506-1 and ISO 9506-2) and to ISO/IEC 8802-3	IEC/TC 57
IEC 61850-8-2	Specific communication service mapping (SCSM) - Mappings to web-services	IEC/TC 57
IEC 61850-90-2	Use of IEC 61850 for the communication between substations and control centers	IEC/TC 57

2341  
2342

Table 10 Standards - Layer Communication, Domain DER, Zones Field and Station

2343  
2344

Figure 57 shows the results of filtering the IOP Tool for zones *Station* and *Operation* on layer *Communication*. Table 11 gives an overview of the identified standards and relevant technical bodies.

	A	B	C	F	AA	AB	BC	BD	BH	BI	BJ	BK	BL	BM	BN	BO
1				Layer	Domain			Zone		Testing						
2				Communication	DER		Station	Operation	Electrical	Mechanical	System	Conformance	Interoperability	Acceptance	N/A	Type / Routine Test
3	Standardization organization	Standards	Title		General	DER management systems										
38	CEN / CENELEC	EN 60870-5-101	Telecontrol equipment and systems - Part 5-101: Transmission protocols; Companion standard for basic telecontrol tasks	X	X	X	X	X								X
41	CEN / CENELEC	EN 60870-5-104	Telecontrol equipment and systems - Part 5-104: Transmission protocols - Network access for IEC 60870-5-101 using standard transport profiles	X	X	X	X	X								X
75	CEN / CENELEC	EN 61400-25-4	Wind turbines - Part 25-4: Communications for monitoring and control of wind power plants - Mapping to communication profile	X	X	X	X	X								X
276	IEC	IEC 61850-8-2	Communication networks and systems for power utility automation - Part 8-2: Specific communication service mapping (SCSM) - Mappings to web-	X	X	X	X	X								X
284	IEC	IEC 61850-90-2	Use of IEC 61850 for the communication between substations and control centres	X	X	X	X	X								X

Figure 57 IOP Tool - Layer Communication, Domain DER, Zones Station and Operation

Standard	Title	Technical Body
EN 60870-5-101	Telecontrol equipment and systems - Part 5-101: Transmission protocols; Companion standard for basic telecontrol tasks	IEC/TC 57
EN 60870-5-104	Telecontrol equipment and systems - Part 5-104: Transmission protocols - Network access for IEC 60870-5-101 using standard transport profiles	IEC/TC 57
EN 61400-25-4	Wind turbines - Part 25-4: Communications for monitoring and control of wind power plants - Mapping to communication profile	IEC/TC 88
IEC 61850-8-2	Specific communication service mapping (SCSM) - Mappings to web-services	IEC/TC 57
IEC 61850-90-2	Use of IEC 61850 for the communication between substations and control centers	IEC/TC 57

Table 11 Standards - Layer Communication, Domain DER, Zones Station and Operation

Figure 58 shows the results of filtering the IOP Tool for zones *Operation* and *Enterprise* on layer *Communication*. Table 12 gives an overview of the identified standards and relevant technical bodies.

id	A	B	C	F	Domain				Testing							BO		
					Layer	DER		Zone		Electrical	Mechanical	System	Conformance	Interoperability	Acceptance		N/A	Type / Routine Test
						Communication	General	DER management systems	Operation									
1	Standardization organization	Standards	Title															
98	CEN / CENELEC	EN 61968 (all parts)	Application integration at electric utilities - System interfaces for distribution management	X	X	X	X	X								X		
100	CEN / CENELEC	EN 61968-100	Application integration at electric utilities - System interfaces for distribution management - Part 100: Implementation Profiles	X	X	X	X	X								X		
109	CEN / CENELEC	EN 61970 (all parts)	Energy management system application program interface (EMS-API)	X	X	X	X	X								X		

Figure 58 IOP Tool - Layer Communication, Domain DER, Zones Operation and Enterprise

Standard	Title	Technical Body
EN 61968 (all parts)	Application integration at electric utilities - System interfaces for distribution management	IEC/TC 57
EN 61968-100	Application integration at electric utilities - System interfaces for distribution management - Part 100: Implementation Profiles	IEC/TC 57
EN 61970 (all parts)	Energy management system application program interface (EMS-API)	IEC/TC 57

Table 12 Standards - Layer Communication, Domain DER, Zones Operation and Enterprise

Figure 58 and Table 12 are relevant to cVPP interaction between different zones, but within the same domain. As mentioned above, in the case of tVPP the DER EMS and VPP system interacts with related DSO systems (cf. Figure 52 and Figure 54). Figure 59 and Table 13 show the results for filtering on systems DMS SCADA and GIS system and DER EMS and VPP systems in layer Communication and zone Operation.

	A	B	C	F	V	Z	AA	AB	BD	BH	BI	BJ	BK	BL	BM	BN	BO	
1	Standardization organization	Standards	Title	Layer	Domain				Zone	Testing							Type / Routine Test	
Communication					Distribution		DER			Operation	Electrical	Mechanical	System	Conformance	Interoperability	Acceptance		N/A
					General	DMS SCADA and GIS system	General	DER management systems										
2	3	100	109	X	X	X	X	X	X							X		
				X	X	X	X	X	X								X	
	CEN / CENELEC	EN 61968-100	Application integration at electric utilities - System interfaces for distribution management - Part 100: Implementation Profiles	X	X	X	X	X	X								X	
	CEN / CENELEC	EN 61970 (all parts)	Energy management system application program interface (EMS-API)	X	X	X	X	X	X								X	

Figure 59 IOP Tool - Layer Communication, Domains DER and DMS SCADA and GIS system, Zone Operation

Standard	Title	Technical Body
EN 61968-100	Application integration at electric utilities - System interfaces for distribution management - Part 100: Implementation Profiles	IEC/TC 57
EN 61970 (all parts)	Energy management system application program interface (EMS-API)	IEC/TC 57

Table 13 Standards - Layer Communication, Domains DER and DMS SCADA and GIS system, Zone Operation

### 12.6.3 Information layer

Figure 60 shows the information layer on the smart grid plane, including the standards listed in the *First Set of Standards report*.

The procedure to identify relevant standards is analogue to the one described for communication layer.

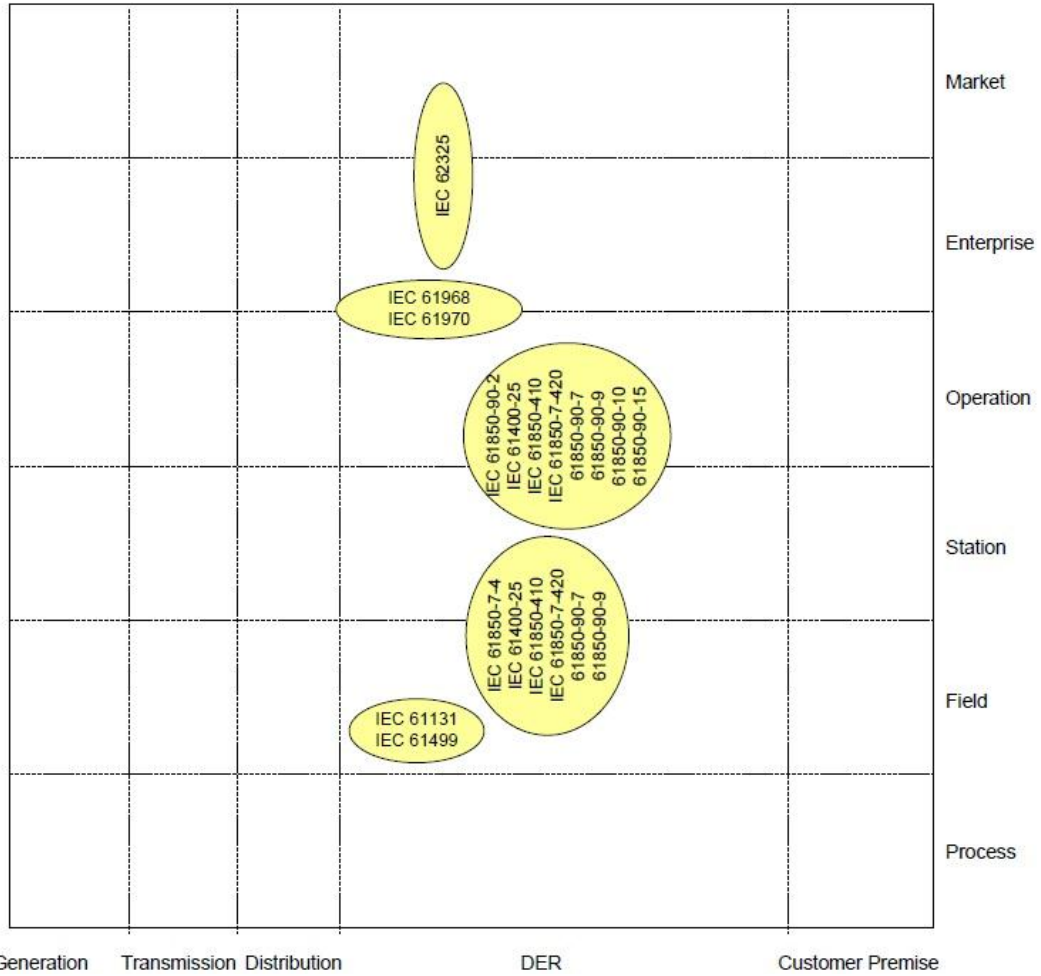

**Figure 60 DER EMS and VPP system - Information layer**

Figure 61 shows the results of filtering the IOP Tool for zone *Field* on layer *Information*. Table 14 gives an overview of the identified standards and relevant technical bodies.



1	2	Standardization organisation	Standards	Title	Layer	Domain			Zone	Testing							Type / Routine Test
						Information	General DER	DER management systems		Field	Electrical	Mechanical	System	Conformance	Interoperability	Acceptance	
72	CEN / CENELEC	EN 61400-25-1	Wind turbines - Part 25-1: Communications for monitoring and control of wind power plants - Overall description of principles and models	X	X	X	X									X	
73	CEN / CENELEC	EN 61400-25-2	Wind turbines - Part 25-2: Communications for monitoring and control of wind power plants - Information models	X	X	X	X									X	
84	CEN / CENELEC	EN 61850-7-4	Communication networks and systems for power utility automation - Part 7-4: Basic communication structure - Compatible logical node classes and data object classes	X	X	X	X						X (partial)				
85	CEN / CENELEC	EN 61850-7-410	Communication networks and systems for power utility automation - Part 7-410: Basic communication structure - Hydroelectric power plants - Communication for monitoring and control	X	X	X	X						X (partial)				
86	CEN / CENELEC	EN 61850-7-420	Communication networks and systems for power utility automation - Part 7-420: Basic communication structure - Distributed energy resources logical nodes	X	X	X	X						X (partial)				
265	CEN / CENELEC	EN 61131	Programmable controllers	X	X	X	X	X	X	X			X				T
267	CEN / CENELEC	EN 61499	Function blocks	X	X	X	X						X	X			
275	IEC	IEC 61850-80-4	Mapping of COSEM metering model over IEC 61850	X	X	X	X									X	
284	IEC	IEC 61850-90-2	Use of IEC 61850 for the communication between substations and control centres	X	X	X	X									X	
289	IEC	IEC 61850-90-7	Communication networks and systems for power utility automation - Part 90-7: IEC 61850 object models for photovoltaic, storage, and other DER	X	X	X	X									X	
290	IEC	IEC 61850-90-9	Object Models for Batteries	X	X	X	X									X	

Figure 61 IOP Tool - Layer Information, Domain DER, Zone Field

Standard	Title	Technical Body
EN 61400-25-1	Wind turbines - Part 25-1: Communications for monitoring and control of wind power plants - Overall description of principles and models	IEC/TC 88
EN 61400-25-2	Wind turbines - Part 25-2: Communications for monitoring and control of wind power plants - Information models	IEC/TC 88
EN 61850-7-4	Communication networks and systems for power utility automation - Part 7-4: Basic communication structure - Compatible logical node classes and data object classes	IEC/TC 57
EN 61850-7-410	Communication networks and systems for power utility automation - Part 7-410: Basic communication structure - Hydroelectric power plants - Communication for monitoring and control	IEC/TC 57
EN 61850-7-420	Communication networks and systems for power utility automation - Part 7-420: Basic communication structure -	IEC/TC 57

2377  
2378  
2379



Standard	Title	Technical Body
	Distributed energy resources logical nodes	
IEC 61131	Programmable controllers	IEC/SC 65B
IEC 61499	Function blocks	IEC/SC 65B
IEC 61850-80-4	Mapping of COSEM metering model over IEC 61850	IEC/TC 57
IEC 61850-90-2	Use of IEC 61850 for the communication between substations and control centres	IEC/TC 57
IEC 61850-90-7	Communication networks and systems for power utility automation - Part 90-7: IEC 61850 object models for photovoltaic, storage, and other DER inverters	IEC/TC 57
IEC 61850-90-9	Object Models for Batteries	IEC/TC 57

Table 14 Standards - Layer Information, Domain DER, Zone Field

2380  
2381  
2382  
2383

Figure 62 shows the results of filtering the IOP Tool for zones *Field* and *Station* on layer *Information*. Table 15 gives an overview of the identified standards and relevant technical bodies.

Standard	Standardization organization	Standards	Title	Layer	Domain		Zone		Testing							Type / Routine Test	
					General	DER management systems	Field	Station	Electrical	Mechanical	System	Conformance	Interoperability	Acceptance	N/A		
72	CEN / CENELEC	EN 61400-25-1	Wind turbines - Part 25-1: Communications for monitoring and control of wind power plants - Overall description of principles and models	X	X	X	X	X								X	
73	CEN / CENELEC	EN 61400-25-2	Wind turbines - Part 25-2: Communications for monitoring and control of wind power plants - Information models	X	X	X	X	X								X	
84	CEN / CENELEC	EN 61850-7-4	Communication networks and systems for power utility automation - Part 7-4: Basic communication structure - Compatible logical node classes and data object classes	X	X	X	X	X					X (partial)				
85	CEN / CENELEC	EN 61850-7-410	Communication networks and systems for power utility automation - Part 7-410: Basic communication structure - Hydroelectric power plants - Communication for monitoring and control	X	X	X	X	X					X (partial)				
86	CEN / CENELEC	EN 61850-7-420	Communication networks and systems for power utility automation - Part 7-420: Basic communication structure - Distributed energy resources logical nodes	X	X	X	X	X					X (partial)				
275	IEC	IEC 61850-80-4	Mapping of COSEM metering model over IEC 61850	X	X	X	X	X								X	
284	IEC	IEC 61850-90-2	Use of IEC 61850 for the communication between substations and control centres	X	X	X	X	X								X	
289	IEC	IEC 61850-90-7	Communication networks and systems for power utility automation - Part 90-7: IEC 61850 object models for photovoltaic, storage, and other DER	X	X	X	X	X								X	
290	IEC	IEC 61850-90-9	Object Models for Batteries	X	X	X	X	X								X	

Figure 62 IOP Tool - Layer Information, Domain DER, Zones Field and Station

2384  
2385  
2386  
2387

Standard	Title	Technical Body
EN 61850-7-4	Communication networks and systems for power utility automation - Part 7-4: Basic communication structure - Compatible logical node classes and data object classes	IEC/TC 57
EN 61850-7-410	Communication networks and systems for power utility automation - Part 7-410: Basic communication structure - Hydroelectric power plants - Communication for monitoring and control	IEC/TC 57
EN 61850-7-420	Communication networks and systems for power utility automation - Part 7-420: Basic communication structure - Distributed energy resources logical nodes	IEC/TC 57
IEC 61850-90-2	Use of IEC 61850 for the communication between substations and control centers	IEC/TC 57
IEC 61850-90-7	Communication networks and systems for power utility automation - Part 90-7: IEC 61850 object models for photovoltaic, storage, and other DER inverters	IEC/TC 57
IEC 61850-90-9	Object Models for Batteries	IEC/TC 57

**Table 15 Standards - Layer *Information*, Domain *DER*, Zones *Field* and *Station***

2388

2389

2390

2391

Figure 63 shows the results of filtering the IOP Tool for zones *Station* and *Operation* on layer *Information*. Table 16 gives an overview of the identified standards and relevant technical bodies.

Standard	Title	Information	Domain			Zone		Testing							Type / Routine Test
			General	DER management systems	Station	Operation	Electrical	Mechanical	System	Conformance	Interoperability	Acceptance	N/A		
														DER	
72	Wind turbines - Part 25-1: Communications for monitoring and control of wind power plants - Overall description of principles and models	X	X	X	X	X									X
74	Wind turbines - Part 25-3: Communications for monitoring and control of wind power plants - Information exchange models	X	X	X	X	X									X
84	Communication networks and systems for power utility automation - Part 7-4: Basic communication structure - Compatible logical node classes and data object classes	X	X	X	X	X						X (partial)			
85	Communication networks and systems for power utility automation - Part 7-410: Basic communication structure - Hydroelectric power plants - Communication for monitoring and control	X	X	X	X	X						X (partial)			
86	Communication networks and systems for power utility automation - Part 7-420: Basic communication structure - Distributed energy resources logical nodes	X	X	X	X	X						X (partial)			
275	Mapping of COSEM metering model over IEC 61850	X	X	X	X	X									X
278	Object Models for Scheduling	X	X	X	X	X									X
279	Communication networks and systems for power utility automation - Part 90-11: Methodologies for modelling of logics for IEC 61850 based	X	X	X	X	X									X
280	Communication networks and systems for power utility automation - Part 90-11: Use of IEC 61850 over WAN	X	X	X	X	X									X
283	Hierarchical DER system model	X	X	X	X	X									X
284	Use of IEC 61850 for the communication between substations and control centres	X	X	X	X	X									X
289	Communication networks and systems for power utility automation - Part 90-7: IEC 61850 object models for photovoltaic, storage, and other DER	X	X	X	X	X									X
290	Object Models for Batteries	X	X	X	X	X									X
327	CIM-IEC 61850 Harmonisation	X	X	X	X	X									X

Figure 63 IOP Tool - Layer Information, Domain DER, Zones Station and Operation

Standard	Title	Technical Body
EN 61400-25-3	Wind turbines - Part 25-3: Communications for monitoring and control of wind power plants - Information exchange models	IEC/TC 88
EN 61850-7-4	Communication networks and systems for power utility automation - Part 7-4: Basic communication structure - Compatible logical node classes and data object classes	IEC/TC 57
EN 61850-7-410	Communication networks and systems for power utility automation - Part 7-410: Basic communication structure - Hydroelectric power plants - Communication for monitoring and control	IEC/TC 57
EN 61850-7-420	Communication networks and systems for power utility automation - Part 7-420: Basic communication structure - Distributed energy resources logical nodes	IEC/TC 57
IEC 61850-90-10	Object Models for Scheduling	IEC/TC 57

Standard	Title	Technical Body
EC 61850-90-11	Communication networks and systems for power utility automation - Part 90-11: Methodologies for modeling of logics for IEC 61850 based applications	IEC/TC 57
EC 61850-90-15	Hierarchical DER system model	IEC/TC 57
EC 61850-90-2	Use of IEC 61850 for the communication between substations and control centers	IEC/TC 57
EC 61850-90-7	Communication networks and systems for power utility automation - Part 90-7: IEC 61850 object models for photovoltaic, storage, and other DER inverters	IEC/TC 57
EC 61850-90-9	Object Models for Batteries	IEC/TC 57

**Table 16 Standards - Layer Information, Domain DER, Zones Station and Operation**

2395

2396

2397

2398

Figure 64 shows the results of filtering the IOP Tool for zones *Operation* and *Enterprise* on layer *Information*. Table 17 gives an overview of the identified standards and relevant technical bodies.

1	A	B	C	G	Domain					Testing							BO
					AA	AB	BD	BE	BH	BI	BJ	BK	BL	BM	BN		
2	Standardization organization	Standards	Title	Layer	Zone					Electrical	Mechanical	System	Conformance	Interoperability	Acceptance	N/A	Type / Routine Test
3					Information	General	DER management systems	Operation	Enterprise								
98	CEN / CENELEC	EN 61968 (all parts)	Application integration at electric utilities - System interfaces for distribution management	X	X	X	X	X								X	
109	CEN / CENELEC	EN 61970 (all parts)	Energy management system application program interface (EMS-API)	X	X	X	X	X								X	
327	IEC	IEC 62361-102	CIM-IEC 61850 Harmonisation	X	X	X	X	X								X	

**Figure 64 IOP Tool - Layer Information, Domain DER, Zones Operation and Enterprise**

2399

2400

2401

Standard	Title	Technical Body
EN 61968 (all parts)	Application integration at electric utilities - System interfaces for distribution management	IEC/TC 57
EN 61970 (all parts)	Energy management system application program interface (EMS-API)	IEC/TC 57
IEC 62361-102	CIM-IEC 61850 Harmonization	IEC/TC 57

**Table 17 Standards - Layer Information, Domain DER, Zones Operation and Enterprise**

2402

2403

2404

### 12.6.4 Further selection of testings to support gap identification

2405

2406

To identify standards that already include conformance and/or IOP testing, the IOP tool provides the possibility to filter a set of standards by available testing requirements.



2407  
2408  
2409

Figure 61 showed the set of standards resulting from filtering the IOP Tool for DER EMS and VPP system, zone *Field* on layer *Information*. Figure 65 shows the results of filtering this set of standards by conformance testing.

2410  
2411

Column *Comment WGI* contains additional information on the standards, e.g. related standardization gaps or Use Cases.

	A	B	G	AA	AB	BB	BH	BI	BJ	BK	BL	BM	BN	BO	BP		
1	Standardization organization	Standards	Layer	Domain			Zone	Testing							Type / Routine Test	Comment WGI	
2				Information	DER			Field	Electrical	Mechanical	System	Conformance	Interoperability	Acceptance			N/A
3					General	DER management systems											
84	CEN / CENELEC	EN 61850-7-4	X	X	X	X					X (partial)				partly by 61850-10 SGCG Report v1.72 Gap 8 - Gen-1 / Dis-2		
85	CEN / CENELEC	EN 61850-7-410	X	X	X	X					X (partial)				partly by 61850-10		
86	CEN / CENELEC	EN 61850-7-420	X	X	X	X					X (partial)				partly by 61850-10 SGCG Report v1.72 Gap 10 - Gen-3 / Ind-2 / HB-2		
265	CEN / CENELEC	EN 61131	X	X	X	X	X	X			X			T	Part 2 (Equipment requirements and tests): Type tests		
267	CEN / CENELEC	EN 61499	X	X	X	X					X	X			Part 2 chapter 4.8 System operation, testing and maintenance Part 4 chapter 4.4 Interoperability provisions, chapter 4.6 Test requirements		

2412

Figure 65 IOP Tool - Conformance testing

2413

2414

2415

In the same way it is possible to filter a set of standards by *Interoperability* testing (cf. Figure 66).

	A	B	G	AA	AB	BB	BH	BI	BJ	BK	BL	BM	BN	BO	BP		
1	Standardization organization	Standards	Layer	Domain			Zone	Testing							Type / Routine Test	Comment WGI	
2				Information	DER			Field	Electrical	Mechanical	System	Conformance	Interoperability	Acceptance			N/A
3					General	DER management systems											
267	CEN / CENELEC	EN 61499	X	X	X	X				X	X				Part 2 chapter 4.8 System operation, testing and maintenance Part 4 chapter 4.4 Interoperability provisions, chapter 4.6 Test requirements		

2416

Figure 66 IOP Tool - Interoperability testing

2417

2418

2419

By filtering for *N/A*, the identification of possible gaps in testing can be supported (cf. Figure 67).

	A	B	G	AA	AB	BB	BH	BI	BJ	BK	BL	BM	BN	BO	BP
1			Layer	Domain			Testing								
2			Information	General	DER	Field	Electrical	Mechanical	System	Conformance	Interoperability	Acceptance	N/A	Type / Routine Test	
3	Standardization organization	Standards													Comment WGI
72	CEN / CENELEC	EN 61400-25-1	X	X	X	X							X		
73	CEN / CENELEC	EN 61400-25-2	X	X	X	X							X		
275	IEC	IEC 61850-80-4	X	X	X	X							X		Not relevant Remains a list of potential solutions SGCG Report v1.72 Gap 26 - Other-1
284	IEC	IEC 61850-90-2	X	X	X	X							X		SGCG Report v1.72 Gap 17 - Dis-3
289	IEC	IEC 61850-90-7	X	X	X	X							X		SGCG Report v1.72 Gap 10 - Gen-3 / Ind-2 / HB-2 SGCG Report v1.72 Gap 11-12 - Gen-4 / Gen-5
290	IEC	IEC 61850-90-9	X	X	X	X							X		SGCG Report v1.72 Gap 10 - Gen-3 / Ind-2 / HB-2

Figure 67 IOP Tool - Testing not available

2420  
2421  
2422  
2423



2424 **12.7 Example: Profiling of DER operation system**

2425 1 ... n application functions on function layer do apply for any given Use Case. For each application function  
2426 one or more BAPs need to be generated on component, communication and/or information layer.

2427 Figure 68 shows the component layer of a DER operation system Use Case. In the following example  
2428 interoperability between the DER plant controller and DER unit controllers shall be considered.

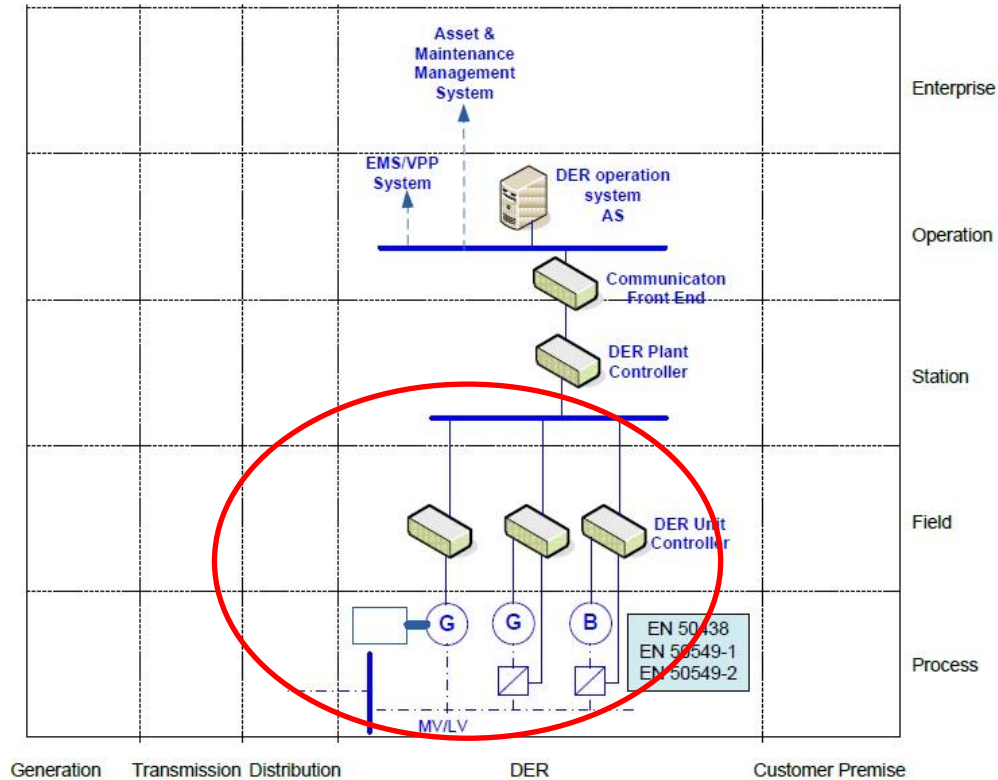

2429

2430

**Figure 68 DER operation system**

2431 Selecting (set of) standards for each interface within each required layer can be supported with the IOP tool.

2432 EN 61850-8-1 defines the communication between DER plant controller and DER unit controllers on  
2433 communication layer.

2434 On information layer several standards are relevant depending on the type of DER unit. The information  
2435 layer is mostly based on the IEC/EN 61850 information model. EN 61850-7-4 is the core part depicting this  
2436 model which is extended by various standards for DER operations:

- 2437 • EN 61850-7-410: Hydroelectric power plants.
- 2438 • EN 61850-7-420: DER logical nodes.
- 2439 • EN 61400-25-2: Wind turbines.
- 2440 • IEC 61850-90-7: PV inverters.
- 2441 • IEC 61850-90-9: Batteries.

2442 This leads to the need for several BAPs, taking each layer and type of DER unit into account.

2443 Also tests have to be done to prove the integration of the system that the devices work properly together  
2444 (System under Test):

- 2445 • Compliance tests according to the applicable standards and.
- 2446 • Interoperability tests according to the BAIOp generated on the basis of the relevant BAPs.

2447

2448

2449 **12.8 Example: use case “Control reactive power of DER unit”**

2450 The sample use case “Control reactive power of DER unit” falls under the area of the distribution  
2451 management. The underlying business objective of the use case is the operation of the distribution system in  
2452 order to deliver electrical energy to customers under consideration of specific constraints (typically economic  
2453 and regulatory oriented).

2454	<u>Related business case</u>
2455	Operation of distribution grid
2456	<u>Scope</u>
2457	Monitor voltage level in distribution grid, control reactive power of DER unit, volt/var control of distribution 2458 grid
2459	<u>Objective</u>
2460	Monitor and control voltage level of distribution grid in tolerated limits

2461 The Use Case diagram for “Control reactive power of DER unit” is shown in Figure 69.

2462

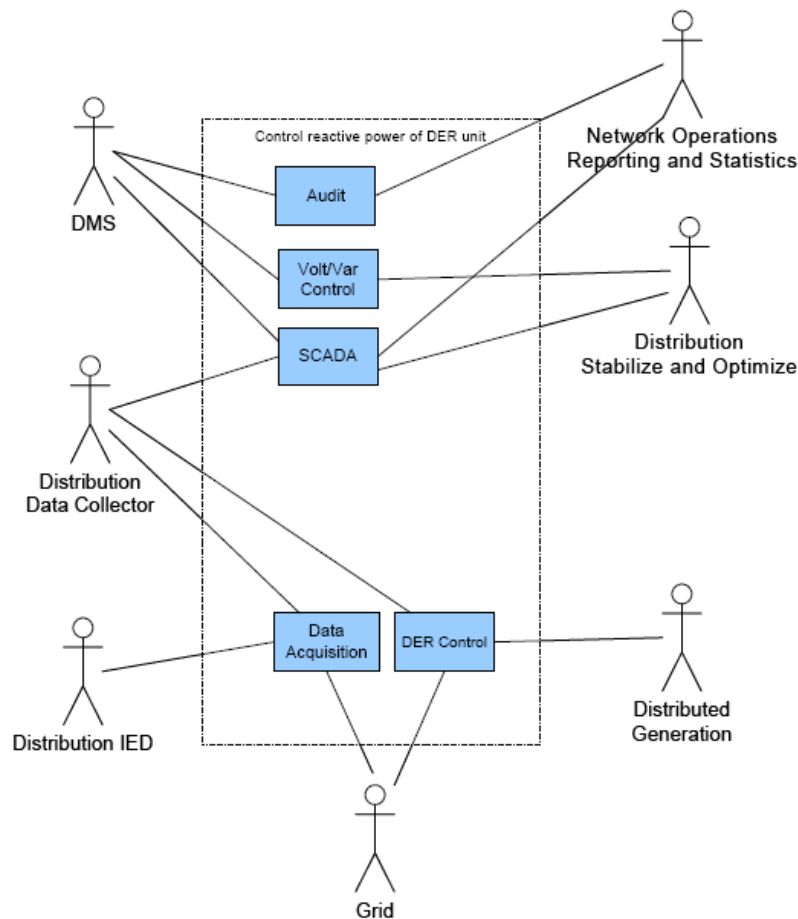

2463

2464

**Figure 69 Use Case Diagram for “Control reactive power of DER unit”**

2465 The content of the component layer is derived from the use case information on actors. These actors are  
2466 located to the appropriate domain and zone (see Figure 70).

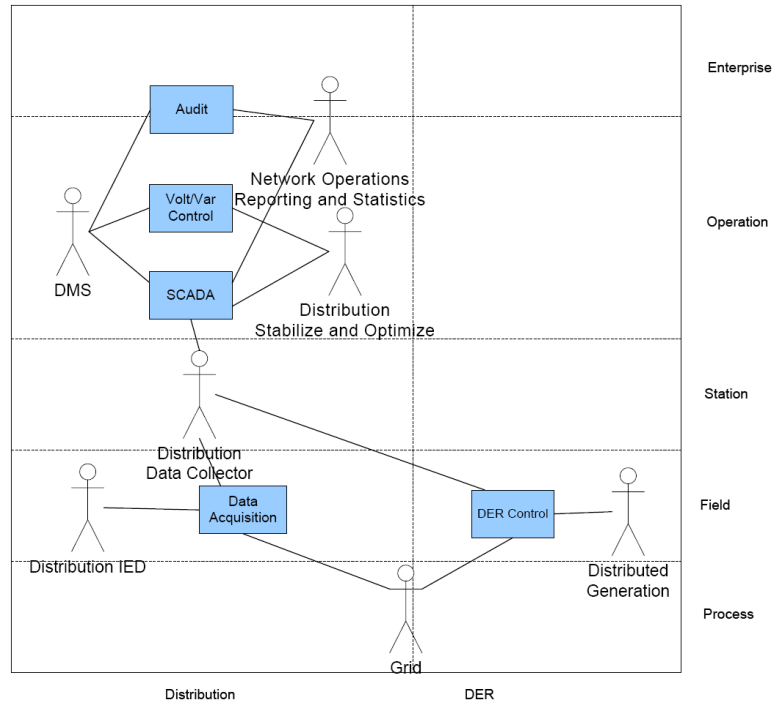

2467  
2468  
2469  
2470  
2471

**Figure 70 Actors and sub use cases mapped to domains and zones**

The component layer depicts the use case actors in form of hardware which is used to provide the intended use case functionality. To complete this view the communication infrastructure is added.

This example focuses on the Head-End System (HES) and the DER Controller (Figure 71).

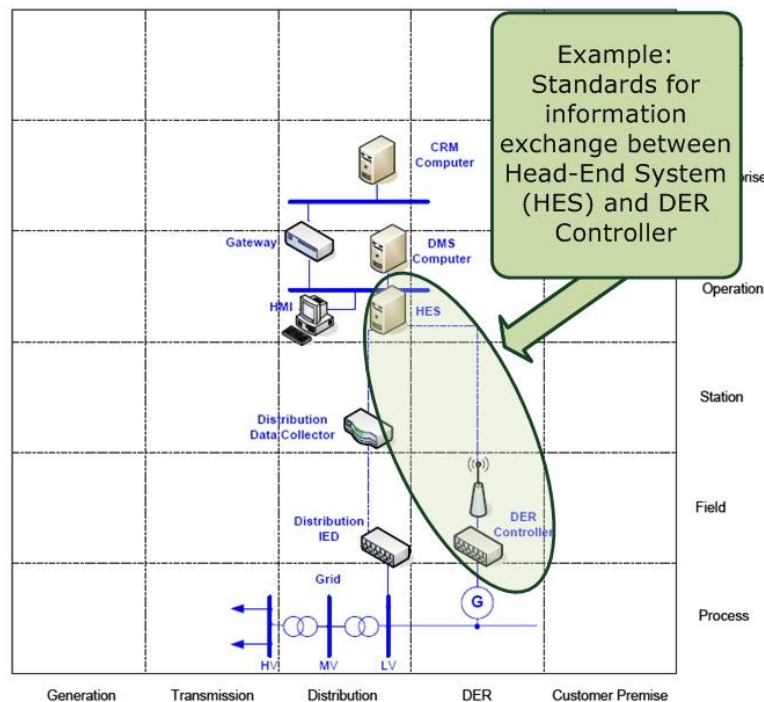

2472  
2473  
2474  
2475

**Figure 71 Component layer**

The example considers information exchange between these components. Therefore the SGAM layer *Information* is chosen. In the IOP Tool the filter in column **H** is set (Figure 72).

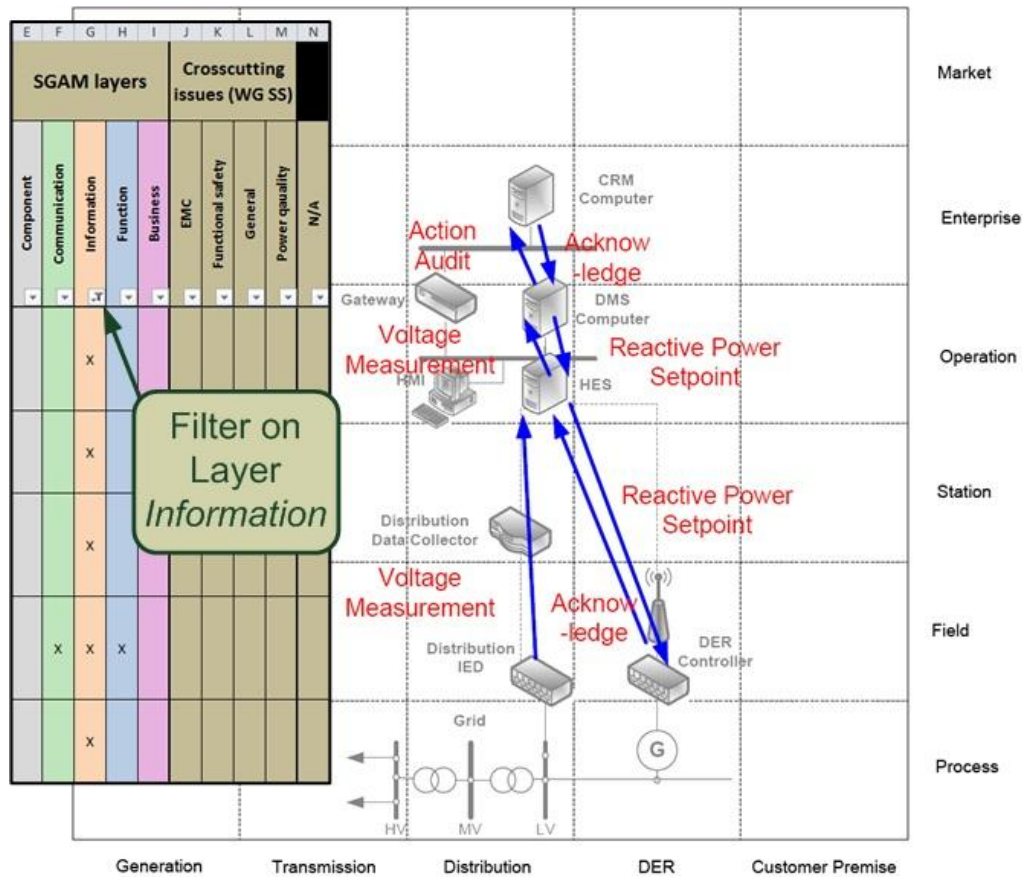

2476  
2477

Figure 72 Filtering for Layer

2478  
2479  
2480

HES is part of domain *Distribution*, DER Controller is part of domain *DER*. Therefore in the next step the filters on the SGAM Domain specific systems *Distributed Power Quality control system* (Domain *Distribution*) and *DER management systems* (Domain *DER*) are set (Figure 73).

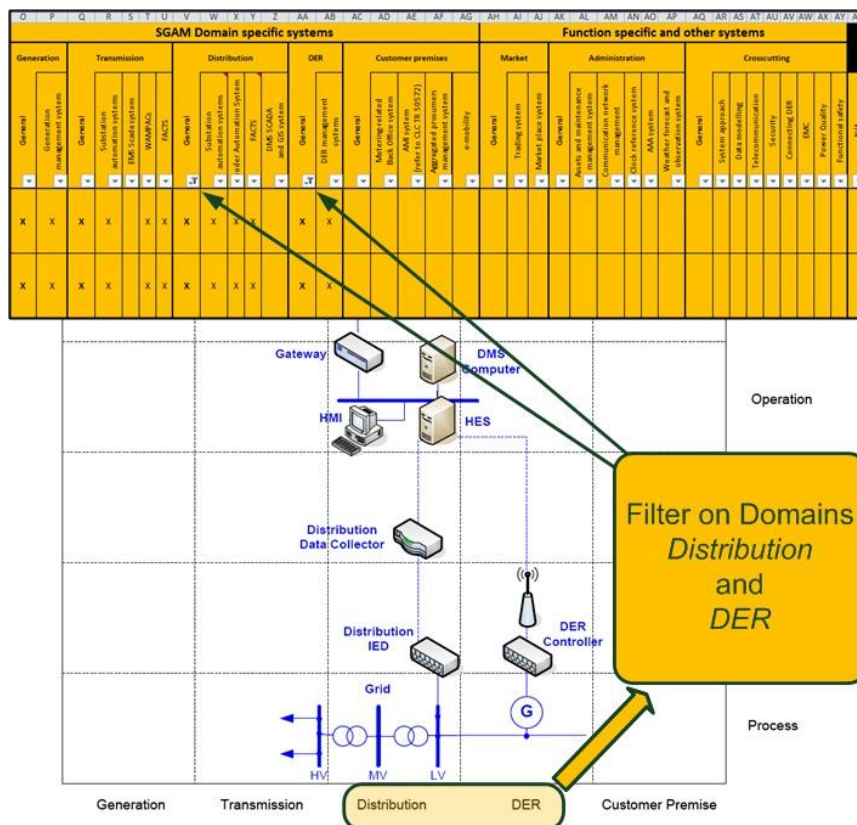

2481  
2482

Figure 73 Filtering for System



2483  
2484

HES is part of zone *Operation*, DER Controller is part of zone *Field*. So in the next step the filters on these zones are set (Figure 74).

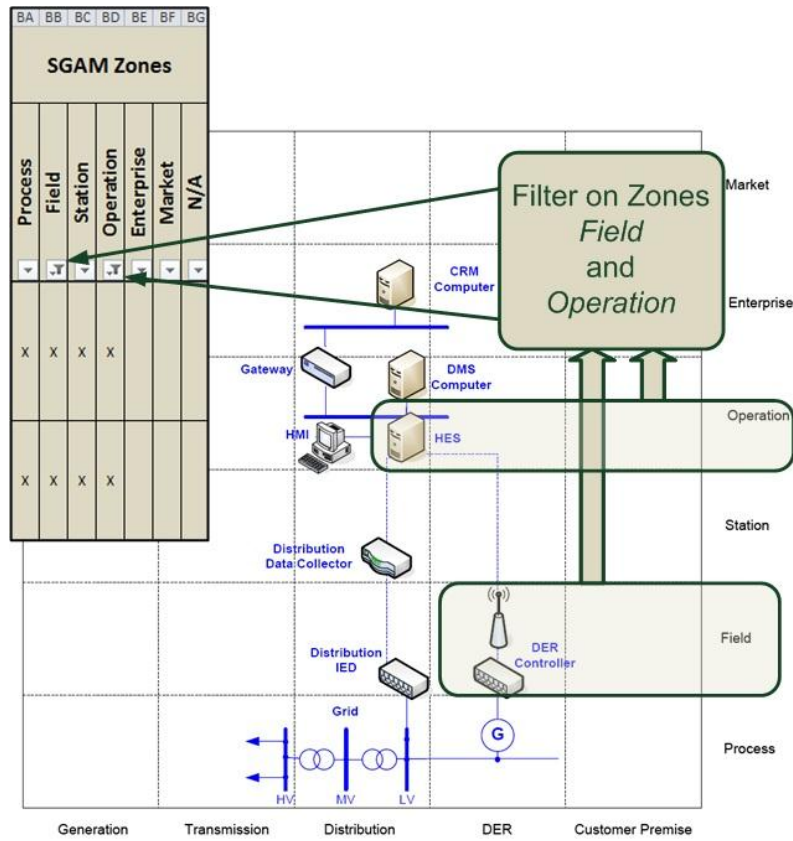

2485  
2486  
2487

Figure 74 Filtering for Zones

After filtering in the way described above a list of standards results (Figure 75) for the prioritized systems.

	A	B	C	D	BP
	Standardization organization	Standards	Title	Abstract	Comment WGI
84	CEN / CENELEC	EN 61850-7-4	Communication networks and systems for power utility automation - Part 7-4: Basic communication structure - Compatible logical node classes and data object classes	Specifies the information model of devices and functions generally related to common use regarding applications in systems for power utility automation. It also contains the information model of devices and function-related applications in substations. In particular, it specifies the compatible logical node names and data object names for communication between intelligent electronic devices	partly by 61850-10 SGCG Report v1.72 Gap 8 - Gen-1 / Dis-2
85	CEN / CENELEC	EN 61850-7-410	Communication networks and systems for power utility automation - Part 7-410: Basic communication structure - Hydroelectric power plants - Communication for monitoring and control	Specifies the additional common data classes, logical nodes and data objects required for the use of IEC 61850 in a hydropower plant.	partly by 61850-10
86	CEN / CENELEC	EN 61850-7-420	Communication networks and systems for power utility automation - Part 7-420: Basic communication structure - Distributed energy resources logical nodes	The document specifies object models of DER information that can be exchanged between DER devices and any systems which monitor, control, maintain, audit, and generally operate the DER devices.	partly by 61850-10 SGCG Report v1.72 Gap 10 - Gen-3 / Ind-2 / HB-2
275	IEC	IEC 61850-80-4	Mapping of COSEM metering model over IEC 61850	Mapping of COSEM metering model over IEC 61850	Not relevant Remains a list of potential solutions SGCG Report v1.72 Gap 26 - Other-1
284	IEC	IEC 61850-90-2	Use of IEC 61850 for the communication between substations and control centres	Use of IEC 61850 for the communication between substations and control centres	SGCG Report v1.72 Gap 17 - Dis-3
289	IEC	IEC 61850-90-7	Communication networks and systems for power utility automation - Part 90-7: IEC 61850 object models for photovoltaic, storage, and other DER	IEC 61850 object models for photovoltaic, storage, and other DER inverters	SGCG Report v1.72 Gap 10 - Gen-3 / Ind-2 / HB-2 SGCG Report v1.72 Gap 11-12 - Gen-4 / Gen-5

2488  
2489

Figure 75 Resulting standards

2490  
2491

In columns *BA* to *BH* the testing described in those resulting standards is listed (Figure 76). For the example Use Case partial IOP testing is currently described in the resulting standards.

	A	B	BH	BI	BJ	BK	BL	BM	BN	BO	BP
1			<b>Testing</b>								
2	Standardization organization	Standards	Electrical	Mechanical	System	Conformance	Interoperability	Acceptance	N/A	Type / Routine Test	Comment WGI
3											
84	CEN / CENELEC	EN 61850-7-4				X (partial)					partly by 61850-10 SGCG Report v1.72 Gap 8 - Gen-1 / Dis-2
85	CEN / CENELEC	EN 61850-7-410				X (partial)					partly by 61850-10
86	CEN / CENELEC	EN 61850-7-420				X (partial)					partly by 61850-10 SGCG Report v1.72 Gap 10 - Gen-3 / Ind-2 / HB-2
275	IEC	IEC 61850-80-4							X		Not relevant Remains a list of potential solutions SGCG Report v1.72 Gap 26 - Other-1
284	IEC	IEC 61850-90-2							X		SGCG Report v1.72 Gap 17 - Dis-3
289	IEC	IEC 61850-90-7							X		SGCG Report v1.72 Gap 10 - Gen-3 / Ind-2 / HB-2 SGCG Report v1.72 Gap 11-12 - Gen-4 / Gen-5

Figure 76 Testing in resulting standards

2492  
2493  
2494  
2495



2496	<b>12.9 List of figures</b>	
2497	Figure 1 Interoperable systems performing a function .....	10
2498	Figure 2 Conformance & Compliance .....	11
2499	Figure 3 Compatibility .....	12
2500	Figure 4 Timeline for standards development .....	13
2501	Figure 5 Mapping from GWAC to SGAM planes .....	14
2502	Figure 6 GWAC stack Context Setting Framework .....	15
2503	Figure 7 Transfer from GWAC to SGAM Context Setting Framework .....	15
2504	Figure 8 System development life cycle .....	17
2505	Figure 9 Creating an interoperable architecture from use cases .....	20
2506	Figure 10 Companies collaborate in User Groups to create a common IOP profile .....	23
2507	Figure 11 Method for payload Creation .....	24
2508	Figure 12 Workflow of standardization process .....	25
2509	Figure 13 V-Model including BAP and BAIOP .....	26
2510	Figure 14 Process from Use Case to Interoperability on SGAM layers .....	27
2511	Figure 15 Device features covered by profiles depending on compatibility levels acc. to TC65 .....	28
2512	Figure 16 Workflow of project specific profiling .....	29
2513	Figure 17 Function mapping on actors and components with information flows .....	30
2514	Figure 18 Use case smart charging mapped on COTEVOS Reference Architecture .....	30
2515	Figure 19 Creating an interoperable architecture from use cases .....	34
2516	Figure 20 conformance testing .....	35
2517	Figure 21 Interoperability testing .....	36
2518	Figure 22 two eMobility use cases in COTEVOS Reference Architecture .....	38
2519	Figure 23 timeline for project execution .....	39
2520	Figure 24 SGAM Smart Grid Plane .....	41
2521	Figure 25 Snapshot of IOP Tool .....	41
2522	Figure 26 IOP Tool - SGAM layers and crosscutting issues .....	42
2523	Figure 27 IOP Tool – Domain specific systems .....	43
2524	Figure 28 IOP Tool - Function specific and other systems .....	43
2525	Figure 29 IOP Tool – Zones .....	44
2526	Figure 30 Conceptual conformance assessment process according to IEC 61850-10 .....	52
2527	Figure 31 Conceptual conformance assessment process according to IEC 60870-5-6 .....	53
2528	Figure 32 Example of test cases out of IEC TS 60870-5-601 .....	54
2529	Figure 33 DLMS/COSEM conformance testing process .....	56
2530	Figure 34 DLMS/COSEM conformance assessment process overview .....	57
2531	Figure 35 FP7 PowerUp System Architecture .....	59
2532	Figure 36 TTCN-3 test suite and test platform .....	59
2533	Figure 37 Illustration of main concepts according to ETSI TS 102 237-1 .....	61
2534	Figure 38 Developing an interoperability test specification according to ETSI TS 102 237-1 .....	61
2535	Figure 39 Conformance Testing according to DLMS UA .....	62

2536	Figure 40 UCAlug Organization Chart.....	63
2537	Figure 41 graphical presentation of assessment of priority.....	69
2538	Figure 42 timeline for standards development.....	80
2539	Figure 43 timeline for project conceptual demonstration.....	81
2540	Figure 44 Steps in the Process from Use Case to Interoperability.....	82
2541	Figure 45 Mapping of the use case actors on the COTEVOS reference architecture.....	83
2542	Figure 46 Information flows between the different function.....	84
2543	Figure 47 Function mapping on actors with information flows.....	84
2544	Figure 48 Use case smart charging in COTEVOS Reference Architecture.....	85
2545	Figure 49 Information flow with multiple routing options.....	85
2546	Figure 50 Example EVSE for discussion on multiple routing information flows.....	86
2547	Figure 51 Two eMobility use cases in the COTEVOS Reference Architecture.....	87
2548	Figure 52 DER EMS and VPP system - Component layer.....	92
2549	Figure 53 IOP Tool - Layer Component, Domain DER, Zone Process.....	93
2550	Figure 54 DER EMS and VPP system - Communication layer.....	94
2551	Figure 55 IOP Tool - Layer Communication, Domain DER, Zone Field.....	95
2552	Figure 56 IOP Tool - Layer Communication, Domain DER, Zones Field and Station.....	96
2553	Figure 57 IOP Tool - Layer Communication, Domain DER, Zones Station and Operation.....	97
2554	Figure 58 IOP Tool - Layer Communication, Domain DER, Zones Operation and Enterprise.....	98
2555	Figure 59 IOP Tool - Layer Communication, Domains DER and DMS SCADA and GIS system, Zone	
2556	Operation.....	99
2557	Figure 60 DER EMS and VPP system - Information layer.....	100
2558	Figure 61 IOP Tool - Layer Information, Domain DER, Zone Field.....	101
2559	Figure 62 IOP Tool - Layer Information, Domain DER, Zones Field and Station.....	102
2560	Figure 63 IOP Tool - Layer Information, Domain DER, Zones Station and Operation.....	104
2561	Figure 64 IOP Tool - Layer Information, Domain DER, Zones Operation and Enterprise.....	105
2562	Figure 65 IOP Tool - Conformance testing.....	106
2563	Figure 66 IOP Tool - Interoperability testing.....	106
2564	Figure 67 IOP Tool - Testing not available.....	107
2565	Figure 68 DER operation system.....	108
2566	Figure 69 Use Case Diagram for “Control reactive power of DER unit”.....	109
2567	Figure 70 Actors and sub use cases mapped to domains and zones.....	110
2568	Figure 71 Component layer.....	110
2569	Figure 72 Filtering for Layer.....	111
2570	Figure 73 Filtering for System.....	111
2571	Figure 74 Filtering for Zones.....	112
2572	Figure 75 Resulting standards.....	112
2573	Figure 76 Testing in resulting standards.....	113
2574		
2575		

2576	<b>12.10 List of tables</b>	
2577	Table 1 selected standards.....	51
2578	Table 2 WGI selected systems based on WG SS.....	67
2579	Table 3 results priority assessment.....	68
2580	Table 4 Required functions from the use case with the initiating actor.....	83
2581	Table 5 List of BAPs required for the first eMobility Smart Charging use case.....	86
2582	Table 6 List of BAPs required for the two selected eMobility use cases.....	87
2583	Table 7 BAIOPs created with list of BAPs for the two selected eMobility use cases.....	90
2584	Table 8 Standards - Layer <i>Component</i> , Domain <i>DER</i> , Zone <i>Process</i> .....	94
2585	Table 9 Standards - Layer <i>Communication</i> , Domain <i>DER</i> , Zone <i>Field</i> .....	95
2586	Table 10 Standards - Layer <i>Communication</i> , Domain <i>DER</i> , Zones <i>Field</i> and <i>Station</i> .....	96
2587	Table 11 Standards - Layer <i>Communication</i> , Domain <i>DER</i> , Zones <i>Station</i> and <i>Operation</i> .....	97
2588	Table 12 Standards - Layer <i>Communication</i> , Domain <i>DER</i> , Zones <i>Operation</i> and <i>Enterprise</i> .....	98
2589	Table 13 Standards - Layer <i>Communication</i> , Domains <i>DER</i> and <i>DMS SCADA and GIS system</i> , Zone	
2590	<i>Operation</i> .....	99
2591	Table 14 Standards - Layer <i>Information</i> , Domain <i>DER</i> , Zone <i>Field</i> .....	102
2592	Table 15 Standards - Layer <i>Information</i> , Domain <i>DER</i> , Zones <i>Field</i> and <i>Station</i> .....	103
2593	Table 16 Standards - Layer <i>Information</i> , Domain <i>DER</i> , Zones <i>Station</i> and <i>Operation</i> .....	105
2594	Table 17 Standards - Layer <i>Information</i> , Domain <i>DER</i> , Zones <i>Operation</i> and <i>Enterprise</i> .....	105
2595		
2596		

2597 **12.11 Bibliography**

- 2598 [1] European Commission, Smart Grid Mandate M/490, Standardization Mandate to European Standardization  
2599 Organizations (ESOs) to support European Smart Grid deployment Mandate M/490 Smart Grids,  
2600 Responsible person: Dr. M SÁNCHEZ JIMÉNEZ ([manuel.sanchez-jimenez@ec.europa.eu](mailto:manuel.sanchez-jimenez@ec.europa.eu)), Brussels, 2011
- 2601 [2] European Commission, EG1 Report, Responsible person: Dr. M SÁNCHEZ JIMÉNEZ ([manuel.sanchez-](mailto:manuel.sanchez-jimenez@ec.europa.eu)  
2602 [jimenez@ec.europa.eu](mailto:manuel.sanchez-jimenez@ec.europa.eu)), Brussels, 2010
- 2603 [3] CEN/CENELEC/ETSI Joint Working Group on Standards for Smart Grids: " Final report of the  
2604 CEN/CENELEC/ETSI Joint Working Group on Standards for Smart Grids ", Brussels, 2011
- 2605 [4] CEN/CENELEC/ETSI Joint Working Group on Standards for Smart Grids: "Recommendations for Smart Grid  
2606 standardization in Europe Standards for Smart Grids", Brussels, 2011
- 2607 [5] IEC Strategic Group 3 Smart Grids: IEC Smart Grid Roadmap, <http://www.iec.ch/smartgrid/roadmap/>,  
2608 Geneva, 2010
- 2609 [6] Framework document of the Smart Grid Coordination Group
- 2610 [7] Report of the Working Group Sustainable Processes
- 2611 [8] Report of the Working Group Reference Architecture
- 2612 [9] Report of the Working Group First set of standards
- 2613 [10] Report of the Working Group Smart Grid Information Security
- 2614

2615

**12.12 References**

- 2616 1) Electricity metering - Glossary of terms, IEC 62051, 1st edition 1999-3(2)
- 2617 2) Electricity metering - Glossary of terms , part 1 - Terms related to data exchange with metering
- 2618 equipment using DLMS/COSEM, IEC 62051-1, 1st edition 2004-1
- 2619 3) System Requirements Specification - version 1 – October 2009 – UCA Iug - OpenSG – AMI-ENT TF
- 2620 4) Utility AMI 2008 Home Area Network System Requirements Specification V1.04, August 19, 2008
- 2621 5) Machine-to-Machine Communications (M2M): Definitions - ETSI draft TR 102 725 V0.3.0
- 2622 6) ETSI Draft TR 102 691 V0.4.1
- 2623 7) Dutch Smart Meter Requirements (DSMR) V3.0, March 2010, Netbeheer Nederland
- 2624 8) EN14154 - Water meters – Part 1 – general requirements and OIML R49-1: 2000
- 2625 9) EN 50470-1:2006 - Electricity metering equipment (a.c.) - Part 1: General requirements, tests and test
- 2626 conditions - Metering equipment (class indexes A, B and C)
- 2627 10) International Electro technical Vocabulary (IEV) Part 691 – Tariffs for electricity
- 2628 11) IEC 62055 - Electricity metering – Payment systems - Parts 21 and 31
- 2629 12) IEC PAS 62559:2008-01: IntelliGrid Methodology for Developing Requirements for Energy Systems
- 2630 13) ISO/IEC/TR 15067-3:2000-10: Information technology - Home Electronic System (HES) application
- 2631 model - Part 3: Model of an energy management system for HES
- 2632 14) ISO/IEC Directives Supplement: Procedures specific to IEC,
- 2633 ISO/IEC DIR IEC SUP Edition 6.0 2011-04
- 2634 15) IEC 60050, International Electro technical Vocabulary (IEV), series, online available as
- 2635 <http://www.electropedia.org/>
- 2636 16) IEC 61360 Standard data elements types with associated classification scheme for electric items, series,
- 2637 Component Data Dictionary (CDD )
- 2638 17) IEC 61968 series, Application integration at electric utilities - System interfaces for distribution
- 2639 management, [www.iec.ch](http://www.iec.ch)
- 2640 18) Smart Grid Coordination Group,
- 2641 <http://www.cenelec.eu/aboutcenelec/whatwedo/technologysectors/smartgrids.html>
- 2642 19) Smart Metering Coordination Group,
- 2643 <http://www.cenelec.eu/aboutcenelec/whatwedo/technologysectors/smartmetering.html>
- 2644 20) IEC TC 8, New Work Item Proposal, 8/1307/NP
- 2645 21) CEN/CLC/ETSI/TR 50572:2011-12, Functional reference architecture for communications in smart
- 2646 metering systems.
- 2647 22) ETSI White Paper No. 3 Achieving Technical Interoperability - the ETSI Approach; Authors: Hans van der
- 2648 Veer, Anthony Wiles; 3rd edition - April 2008
- 2649 <http://www.etsi.org/images/files/ETSIWhitePapers/IOP%20whitepaper%20Edition%203%20final.pdf>
- 2650 23) ETSI TS 102 237-1 V4.1.1 (2003-12) Telecommunications and Internet Protocol Harmonization Over
- 2651 Networks (TIPHON) Release 4; Interoperability test methods and approaches; Part 1: Generic approach
- 2652 to interoperability testing.
- 2653 [http://www.etsi.org/deliver/etsi\\_ts/102200\\_102299/10223701/04.01.01\\_60/ts\\_10223701v040101p.pdf](http://www.etsi.org/deliver/etsi_ts/102200_102299/10223701/04.01.01_60/ts_10223701v040101p.pdf)
- 2654 24) IEC 61850-10 ed. 2.0 (2012-12) Communication networks and systems for power utility automation - Part
- 2655 10: Conformance testing
- 2656 25) DLMS User Association TR DLMS/COSEM Conformance Testing Process EXCERPT FROM DLMS UA
- 2657 1001-1:2010, Fourth Edition. [http://dlms.com/documents/Excerpt\\_YB4.pdf](http://dlms.com/documents/Excerpt_YB4.pdf)
- 2658 26) TTCN-3 (ES 201 873) <http://www.ttcn-3.org/>
- 2659 27) ETSI EG 202 798 - Intelligent Transport Systems (ITS); Testing; Framework for conformance and
- 2660 interoperability testing
- 2661 28) ISO/IEC 9646 (all parts): "Information technology - Open Systems Interconnection - Conformance testing
- 2662 methodology and framework"
- 2663 29) A Cockburn "Writing effective use cases"

2664



2665	<b>12.13 Other sources</b>
2666	CEN/CENELEC/ETSI the SGCG Reports
2667	SG-CG/M490/A_ Framework for Smart Grid Standardization
2668	SG-CG/M490/B_ Smart Grid First set of standards
2669	SG-CG/M490/C_ Smart Grid Reference Architecture
2670	SG-CG/M490/D_ Smart Grid Information Security
2671	SG-CG/M490/E_ Smart Grid Use Case Management Process
2672	SG-CG/M490/F_ Overview of SG-CG Methodologies [SG-CG/F]
2673	SG-CG/M490/G_ Smart Grid Set of Standards [SG-CG/G]
2674	SG-CG/M490/H_ Smart Grid Information Security [SG-CG/H]
2675	SG-CG/M490/I_ Smart Grid Interoperability [SG-CG/I]
2676	SG-CG/M490/J_ Conceptual model – market models [SG-CG/J]
2677	SG-CG/M490/K_ SGAM usage and examples [SG-CG/K]
2678	SG-CG/M490/L_ Flexibility Management [SG-CG/L]
2679	Framework document of SGCG, summarizing all above-mentioned reports of the different working Groups
2680	EBSII report V3.0 Part 1 ---- definition IOP
2681	EBSII report V3.0 Part 2 ---- see Glossary
2682	EBSII report V3.0 Part 3 ----see References
2683	

2684 **12.14 Summary about the work of the Working Group Interoperability**

2685 The Working Group Interoperability (WGI) being part of the Smart Grid Coordination Group (SG-CG) have 63  
2686 members and approximately 15 active participants contributing to the meetings and work of the WG SP.

2687 The WGI meet internally in 2013 5 times in a combined F2F and web conference (5 March kick-off). All F2F  
2688 meetings were 2 days meetings.

2689 In 2014 the work was continued with 7 combined F2F and web meetings and 9 single web meetings.

2690 Several conference calls have been used for coordination and exchange Information and discussions for the  
2691 three work streams.

2692 Further meetings were scheduled until the end of the year. Conference calls are executed roughly on a  
2693 weekly basis.

2694 Beneath the these internal meetings the WGI carried out following public stakeholder activities:

2695 - ENTSO-E

2696 - NIST

2697 Furthermore the WG participated in the SG-CG plenary, steering group as well as in the meetings with EC  
2698 reference group, the alignment workshop, the international plenary.

2699 WGI delivered contributions to WG-ST and supplied a list of gaps in the Standard list.

2700 Many stakeholders and committees were interested in the work of the WGI. For example the WGI worked  
2701 together with IEC/TC8.

2702 In the second phase the most important work was the launching of two assessments. The first one was  
2703 focused on the availability of profiles in the current situation. The second was focused on the domains were  
2704 work on profiling is indicated as most critical. Results are described in section 11.

2705 The report was restructured and the a few chapters are added. Most important are the conclusions and  
2706 recommendations (section 4). Some annexes are added with examples of how the proposed methodology is  
2707 already in use in different situations (section 12.3 to 12.8).

2708